

EN



Movement by Perfection



The Royal League in ventilation, control and drive technology



[Product documentation](#)

Type  
FN030-4IH.ZC.V5P4

Article number  
178119

Article number  
178119

# The Royal League

## Die Königsklasse

### Product documentation

ZIEHL-ABEGG Contact  
Trembowelski, Tomasz / ZA Poland  
[Tomasz.Trembowelski@ziehl-abegg.pl](mailto:Tomasz.Trembowelski@ziehl-abegg.pl)

ZIEHL-ABEGG Subsidiary  
Poland ZIEHL-ABEGG Polska Sp. z o.o.  
ul. Wojska Polskiego 7  
05-850 Macierzysz  
POLAND  
Phone + 48 22 351 707 0  
Fax +48 22 665 01 34  
[www.ziehl-abegg.pl](http://www.ziehl-abegg.pl)  
[biuro@ziehl-abegg.pl](mailto:biuro@ziehl-abegg.pl)

Type  
FN030-4IH.ZC.V5P4

Article number  
178119



### Table of Contents

1.	Recitals	4
2.	Product Specification - Technical Data	5
3.	Characteristic Curve	7
4.	Drawing	8
5.	Connection Diagram	9
6.	EU-Declaration of Conformity	10
7.	UKCA Declaration of Incorporation	12

### 1. Recitals

The Product Specifications contained in this document are final, unless otherwise stated by a separate provision in the "ZIEHL-ABEGG deviation list document" with respect to information provided by the customer (cp. separate Chapter: Attachment).

Other regulations between the parties, regardless of time, form or content, are not part of the subject matter of the contract and the agreement on characteristics/of features (Product Specifications) between the parties.

Compliance with the following specifications is mandatory to ensure the functionality and safety of the product. If the following specifications given especially but not limited for operating conditions, transport, storage, mounting, start-up, maintenance and repair are not observed, the product may not operate safely and may cause a hazard to the life and limb of users and third parties.

Deviations from the following requirements may therefore lead both to the loss of the statutory material defect liability rights and to the liability of the buyer for the product that has become unsafe due to the deviation from the specifications.

## 2. Product Specification - Technical Data

<b>Article number</b>	178119
<b>Type key</b>	FN030-4IH.ZC.V5P4
<b>Designation</b>	Axial fan with sickle blades
<b>Fan design</b>	with pipe socket.
<b>Rated values</b>	1~200-240V 50/60Hz P(1)170W 1.70-1.40A 2370 min <sup>-1</sup> 50°C
<b>Electrical connection</b>	Integrated controller with variable cable 3x 0,82 mm <sup>2</sup> and 4x 0,325 mm <sup>2</sup> x 50 cm
<b>Conformity</b>	ErP 2015, ErP2026-Status: Compliant (complete fan)
<b>ErP Data</b>	Measurement category ErP: A Air flow q(v) on Eta opt: 1745 m <sup>3</sup> /h Pressure increase p(fs) on Eta opt: 109 Pa Input power P(ed) on Eta opt: 141 W Efficiency H(statA): 44 % Efficiency grade: N(actual) = 55.7 / N(target) = 40* *ErP 2015
<b>Thermal class</b>	THCL155
<b>Type PFC integrated</b>	no PFC
<b>Painting motor</b>	Fan unpainted
<b>Material rotor</b>	Steel
<b>Painting rotor</b>	Rotor 2 coat paint
<b>Colour rotor</b>	RAL 5002 (ultramarine blue)
<b>Material blades/impeller</b>	High Performance Composite Material
<b>Painting impeller</b>	Blades unpainted
<b>Colour impeller</b>	blue
<b>Painting inlet nozzle</b>	Bell mouth unpainted
<b>Colour inlet nozzle</b>	black
<b>Connection diagram</b>	wiring diagram: 1360-404
<b>Fitting position</b>	H/Vu/Vo
<b>Motor protection</b>	integrated active temperature management
<b>Type of protection</b>	IP54
<b>Impregnation</b>	Moisture and hot climate protection
<b>Quality of bearings</b>	ball bearing with long-time lubrication
<b>Labelling UL/CSA</b>	E347018 ZB-155, MK055-0011
<b>Colour motor</b>	Fan unpainted.
<b>Cable length</b>	50 cm
<b>Cable quality</b>	PVC
<b>Rating plate</b>	1x fixed
<b>Condens. drain holes</b>	Condensation drain hole rotor open
<b>Guard grille type</b>	ring grill
<b>Control</b>	ECblue basic+ torque-regulated
<b>Miscellaneous</b>	
<b>Special mounted part</b>	Wall ring plate made of composite material
<b>Number of blades</b>	5

# The Royal League

## Die Königsklasse

**Article number**  
178119

**Blade setting**

P

**Number of conductor**

3x 0,82 mm<sup>2</sup> and 4x 0,325 mm<sup>2</sup> x

**VDE number**

E912

**Operating manual**

L-BAL-F067

**Weight**

2.60 kg

**Disclaimer CT20/DOE**

Selected product is not governed by U.S. DOE and CT20 industrial fan and blower regulations.

\*\*\* Operation mode: Continuous operation with occasional starts (S1) according to DIN EN 60034-1:2011-02. Occasional starting between -30 °C and -25 °C is permissible. Continuous operation below -25 °C only with special bearings for refrigeration applications on request.

### 3. Characteristic Curve

1~200-240V 50Hz

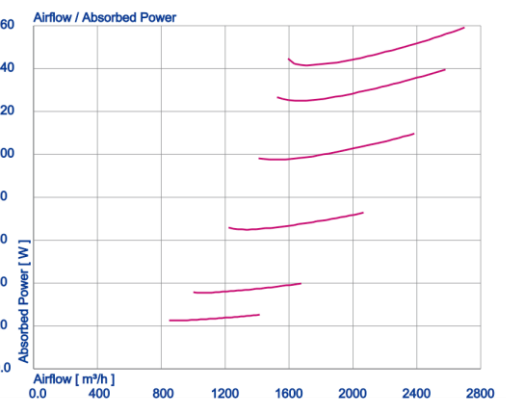
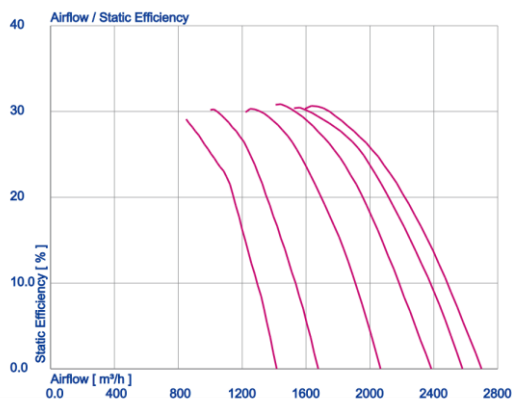
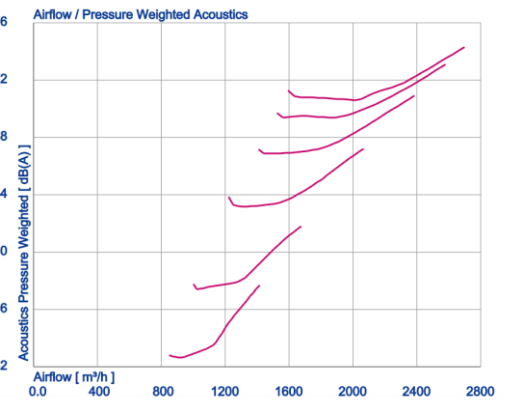
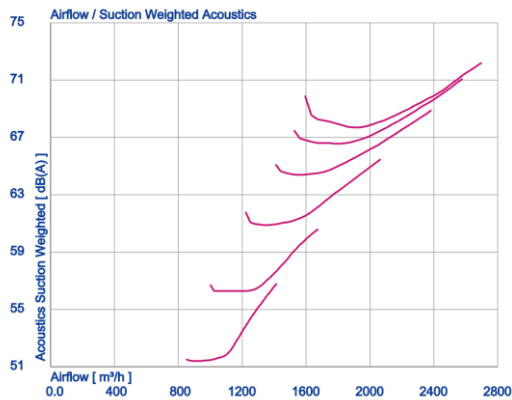
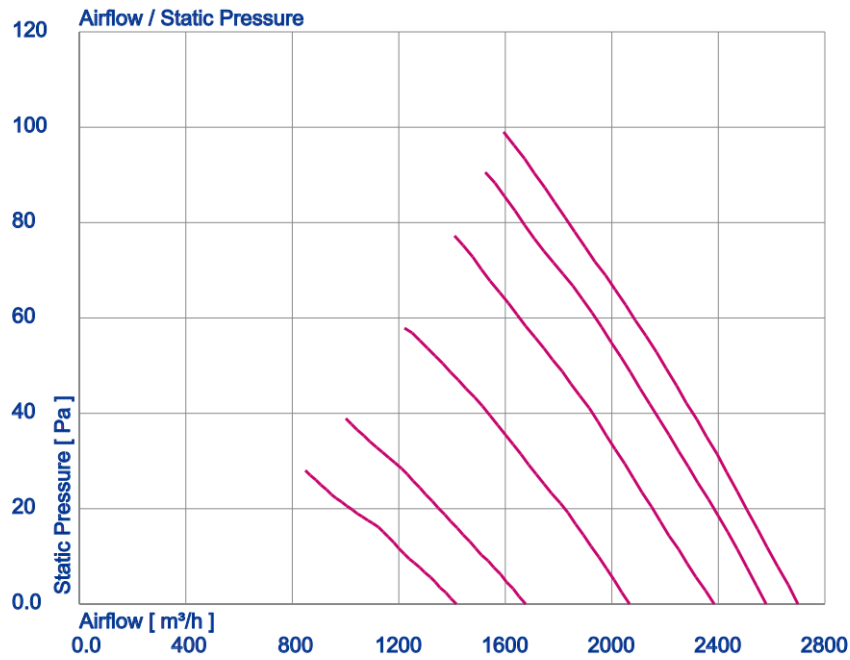



### 5. Connection Diagram

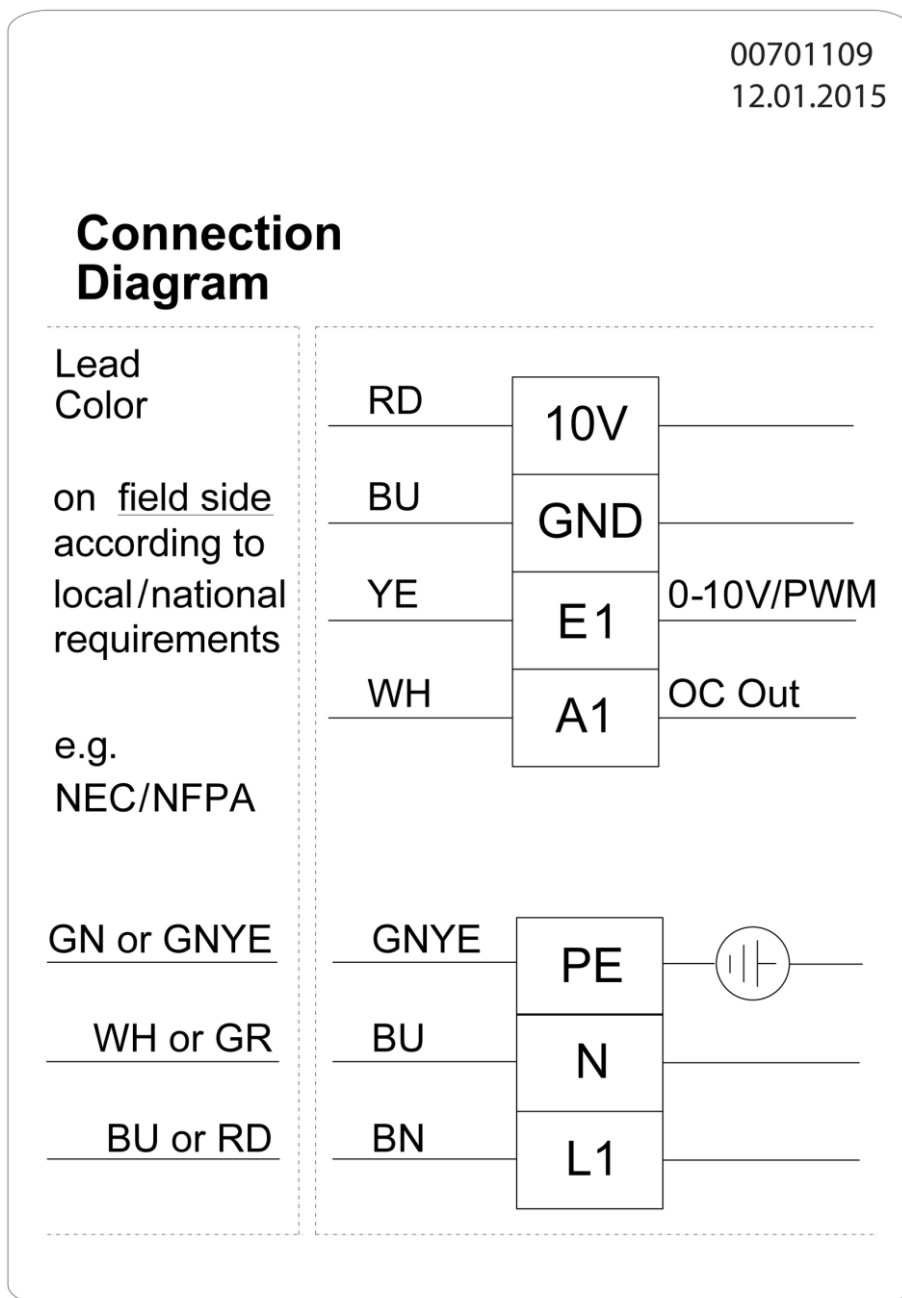

## 6. EU-Declaration of Conformity

### EU declaration of conformity

- Translation -  
(english)  
ZA75-GB 2024/43 Index 020

**Manufacturer:** ZIEHL-ABEGG SE  
Heinz-Ziehl-Straße  
74653 Künzelsau  
Germany

The manufacturer is solely responsible for issuance of the declaration of conformity.

#### The products:

- External rotor motor MK.., MW..
- Axial fan DN.., FA.., FB.., FC.., FE.., FF.., FG.., FH.., FL.., FN.., FP.., FS.., FT.., FV.., SG.., VN.., VR.., ZC.., ZF.., ZG.., ZN..
- Centrifugal fan ER.., GR.., HR.., RA.., RD.., RE.., RF.., RG.., RH.., RK.., RM.., RR.., RZ.., WR..

#### Motor type:

- Asynchronous internal or external rotor motor
- Asynchronous internal or external rotor motor with integrated frequency inverter
- Electronically commutated internal or external rotor motor
- Electronically commutated internal or external rotor motor with integrated EC controller

The above mentioned products of this declaration fulfil all relevant provisions of the following Directives of the Union:

- EMC Directive 2014/30/EU
- Low Voltage Directive 2014/35/EU
- ErP Directive 2009/125/EC, in conjunction with Regulation (EU) no. 327/2011

#### The following harmonized standards have been applied:

- EN 60034-1:2010 + AC:2010
- EN 60204-1:2018
- EN 60529:1991 + A1:2000 + A2:2013 + AC:1993 + AC:2016 + AC:2019
- EN 61000-6-2:2005 + AC:2005
- EN 61000-6-3:2007 + A1:2011 + AC:2012

#### The following additional standards were applied:

- EN IEC 61000-6-2:2019
- EN IEC 61000-6-3:2021

Compliance with the ErP Directive 2009/125/EC does not refer to external rotor motors MK.., MW..

All ErP-relevant information comprises measurements which are determined using a standardised measurement set-up. More details can be obtained from the manufacturer.

Compliance with the EMC Directive 2014/30/EU refers only to those products when they are connected by mounting / operating instructions. If these products are integrated into a system or supplemented with other components (e.g. sensing controls) and operated, the manufacturer or operator is responsible of the overall system for compliance with the EMC Directive 2014/30/EU.

Künzelsau, 22.10.2024  
(Location, date of issue)

ZIEHL-ABEGG SE  
Moritz Krämer  
Director Product Development  
Ventilation Technology  
(name, function)



(signature)

ZIEHL-ABEGG SE  
Jürgen Albig  
Global President  
Product Unit Ventilation  
(name, function)



(signature)

ZIEHL-ABEGG 

### EC Declaration of Incorporation

- Translation -  
(english)  
ZA87-GB 2024/43 Index 014

as defined by the EC Machinery Directive 2006/42/EC, Annex II B

#### The design of the partly completed machine:

- Axial fan DN..., FA..., FB..., FC..., FE..., FF..., FG..., FH..., FL..., FN..., FP..., FS..., FT..., FV..., SG..., VN..., VR..., ZC..., ZF..., ZG..., ZN...
- Centrifugal fan ER..., GR..., HR..., RA..., RD..., RE..., RF..., RG..., RH..., RK..., RM..., RR..., RZ..., WR...

#### Motor type:

- Asynchronous internal or external rotor motor
- Asynchronous internal or external rotor motor with integrated frequency inverter
- Electronically commutated internal or external rotor motor
- Electronically commutated internal or external rotor motor with integrated EC controller

Complies with the requirements in Appendix I, Articles 1.1.2, 1.1.5, 1.4.1, 1.5.1 in EC Machinery Directive 2006/42/EC.

The manufacturer is **ZIEHL-ABEGG SE**  
Heinz-Ziehl-Straße  
D-74653 Künzelsau

#### The following harmonized standards have been applied:

EN 60204-1:2018	Safety of machinery – Electrical equipment of machines – Part 1: General requirements
EN ISO 12100:2010	Safety of machinery – General principles for design – Risk assessment and risk reduction
EN ISO 13857:2019	Safety of machinery – Safety distances to prevent hazard zones being reached by upper and lower limbs
Note:	Compliance with EN ISO 13857:2019 relates only to the installed contact protection if it is part of the scope of delivery.

The special technical documents in accordance with Appendix VII B have been created and are available in full.

The following persons are authorized to compile the technical documents, address see above.

Upon reasonable request, the special documents shall be transmitted to the public authority. The transfer can be made electronically, on data carriers or on paper. All property rights remain with the aforementioned manufacturer.

**Start-up of this incomplete machine is prohibited until it is ensured that the machine in which it has been installed complies with the provisions of the EC Machinery Directive.**

Künzelsau, 22.10.2024  
(Location, date of issue)

ZIEHL-ABEGG SE  
Moritz Krämer  
Director Product Development  
Ventilation Technology  
(name, function)

  
(signature)

ZIEHL-ABEGG SE  
Jürgen Albig  
Global President  
Product Unit Ventilation  
(name, function)

  
(signature)



## 7. UKCA Declaration of Incorporation

### UK Declaration of Conformity

- Original -  
(english)  
ZA75\_UK-GB  
2024/43 Index 005

**Manufacturer:** ZIEHL-ABEGG SE  
Heinz-Ziehl-Straße  
74653 Künzelsau  
Germany

The manufacturer is solely responsible for issuance of the declaration of conformity.

#### The products:

- External rotor motor MK., MW..
- Axial fan DN., FA., FB., FC., FE., FF., FG., FH., FL., FN., FP., FS., FT., FV., SG., VN., VR., ZC., ZF., ZG., ZN..
- Centrifugal fan ER., GR., HR., RA., RD., RE., RF., RG., RH., RK., RM., RR., RZ., WR..

#### The motor type:

- Asynchronous internal or external rotor motor
- Asynchronous internal or external rotor motor with integrated frequency inverter
- Electronically commutated internal or external rotor motor
- Electronically commutated internal or external rotor motor with integrated EC controller

#### These products comply with the following UK directives:

- Electromagnetic Compatibility Regulations 2016 No. 1091
- Electrical Equipment (Safety) Regulations 2016 No. 1101
- The Ecodesign for Energy-Related Products and Energy Information (Amendment) (EU Exit) Regulations 2019 No. 539

#### The following designated standards have been used:

- EN 60034-1:2010 + AC:2010
- EN 60204-1:2018
- EN 60529:1991 + A1:2000 + A2:2013 + AC:1993 + AC:2016 + AC:2019
- EN 61000-6-2:2005 + AC:2005
- EN 61000-6-3:2007 + A1:2011 + AC:2012

#### The following additional standards were applied:

- EN IEC 61000-6-2:2019
- EN IEC 61000-6-3:2021

Compliance with the Ecodesign for Energy-Related Products and Energy Information (Amendment) (EU Exit) Regulations 2019 does not refer to external rotor motors MK., MW..

All ERP-relevant information comprises measurements which are determined using a standardised measurement set-up. More details can be obtained from the manufacturer.

Compliance with the Electromagnetic Compatibility Regulations 2016 refers only to those products when they are connected by mounting / operating instructions. If these products are integrated into a system or supplemented with other components (e.g. sensing controls) and operated, the manufacturer or operator is responsible of the overall system for compliance with the Electromagnetic Compatibility Regulations 2016.

Künzelsau, 22.10.2024  
(location, date of issue)

ZIEHL-ABEGG SE  
Moritz Krämer  
Director Product Development  
Ventilation Technology  
(name, function)



(signature)

ZIEHL-ABEGG SE  
Jürgen Albig  
Global President  
Product Unit Ventilation  
(name, function)



(signature)

**ZIEHL-ABEGG** 

### UKCA Declaration of Incorporation

as defined by the Supply of Machinery (Safety) Regulations 2008  
No. 1597, PART 2 / Annex II B

- Original -  
(english)  
ZA87\_UK-GB  
2022/17 Index 002

**The design of the incomplete machine:**

- Axial fan DN..., FA..., FB..., FC..., FE..., FF..., FG..., FH..., FL..., FN..., FP..., FS..., FT..., FV..., VN..., VR..., ZC..., ZF..., ZG..., ZN...
- Centrifugal fan ER..., GR..., HR..., RA..., RD..., RE..., RF..., RG..., RH..., RK..., RM..., RR..., RZ..., WR...
- Cross-flow fan QD..., QG..., QK..., QR..., QT...

**The motor type:**

- Asynchronous internal or external rotor motor (also with integrated frequency inverter)
- Electronically commutated internal or external rotor motor (also with integrated EC controller)

complies with the requirements in Annex I, Articles 1.1.2, 1.1.5, 1.4.1, 1.5.1 in Supply of Machinery (Safety) Regulations 2008 No. 1597.

The manufacturer is **ZIEHL-ABEGG SE**  
Heinz-Ziehl-Straße  
D-74653 Künzelsau

**The following harmonised standards have been used:**

EN 60204-1:2018	Safety of machinery; electrical equipment of machines; Part 1: General requirements
EN ISO 12100:2010	Safety of machinery - General principles for design - Risk assessment and risk reduction
EN ISO 13857:2019	Safety of machinery; safety distances to prevent danger zones being reached by the upper limbs
Note:	The maintenance of the EN ISO 13857:2019 relates only to the installed accidental contact protection, provided that it is part of the scope of delivery.

The specific technical documentation in accordance with Annex VII B has been written and is available in its entirety.

The following persons are authorized to compile the technical documents, address see above.

The specific documentation will be transmitted to the official authorities on justified request. The transmission can be electronic, on data carriers or on paper. All industrial property rights remain with the above-mentioned manufacturer.

**It is prohibited to commission this incomplete machine until it has been secured that the machine into which it was incorporated complies with the stipulations of the Machinery (Safety) Regulations.**

Künzelsau, 27.04.2022  
(location, date of issue)

ZIEHL-ABEGG SE  
Tobias Gauss  
Deputy Head of Technics Ventilation Technology  
(name, function)



(signature)

ZIEHL-ABEGG SE  
Moritz Krämer  
Head of Electrical Systems  
(name, function)



(signature)

**ZIEHL-ABEGG** 



The Royal League in ventilation, control and drive technology

## Intelligent control technology for any application

**ZIEHL-ABEGG system capabilities:**

**Everything from a single source – perfectly matched for optimal performance**

Please contact us. We would be pleased to design an individual solution for your requirements.

We would like to welcome you on our worldwide exhibitions. Please find our next exhibitions here.

[ZIEHL-ABEGG EVENTS](#)