

Kolor	Przezroczysty	Materiał	PCW
Ø przewodów (mm)	25	Electrocod	210

### DIMENSIONAL

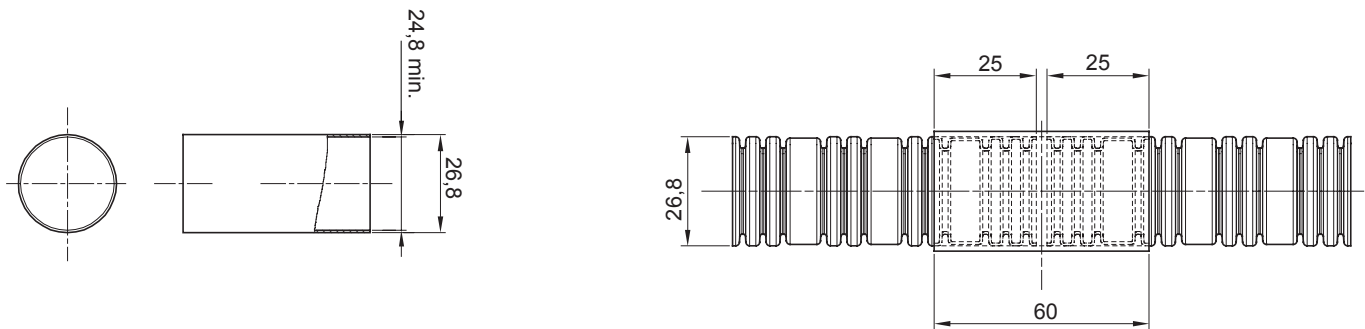

### STANDARDS/APPROVALS

