

36

3615

RAST 5 connectors, pitch 5.0 mm

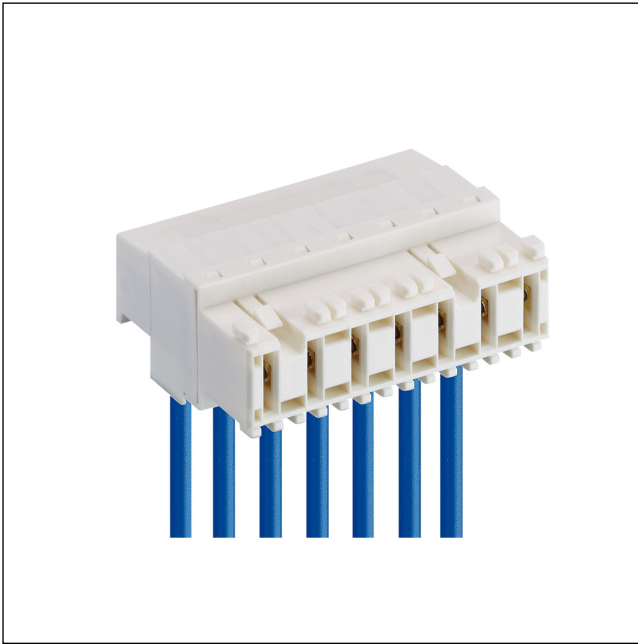

RAST 5 connector for indirect mating, with screw terminal, with lift clamp with protection against misplacing, with test holes and interior locking, consecutive placement without loss of pitch, cable departure opposite to lock

Approvals:



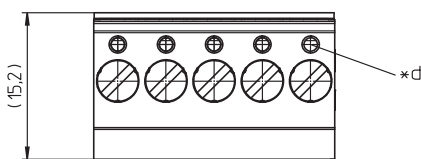
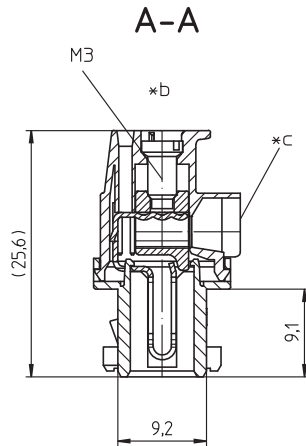
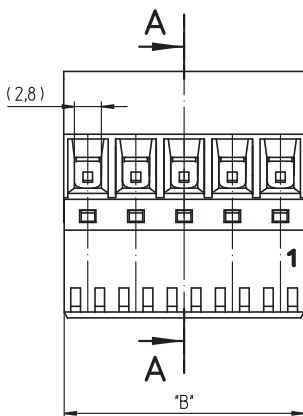
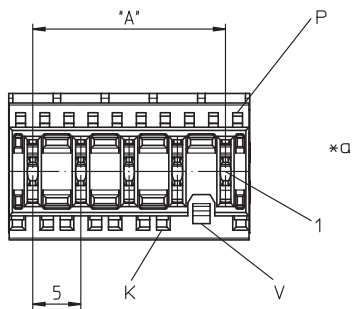

- *a K = keying
P = positioning
V = lock
- *b all screw clamps of the connector to be tightened with the indicated torque
- *c cable departure 90°
- *d hole for test spike \varnothing 1.3 mm

Environmental conditions

Temperature range -40 °C/+130 °C¹

¹ upper limit temperature (insulating body) RTI (electrical) of the UL Yellow Card

Materials

Insulating body PA GF, V-2 according to UL94¹
 Contact spring CuSn, tin-plated
 Clamp CuZn, nickel-plated
 Screw steel, zinc-plated and chromatiert

¹ component glow wire resistant (GWT 750 °C), testing acc. to IEC 60695-2-11, assessment acc. to IEC 60335-1 (flame < 2 s)

Mechanical data

Insertion force/contact \leq 4,0 N
 Withdrawal force/contact \geq 1,0 N
 Tightening torque screw 0,5 Nm
 Keying proposals at www.lumberg.com 

Connectable conductors for screw clamp



















Section stranded wire 0,14–2,5 mm² (AWG 26–14)
 Section stranded wire with ferrule 0,25–2,5 mm² (AWG 24–14)
 Section solid wire 0,14–4,0 mm² (AWG 26–12)
 Stripping length 8 ± 1 mm

Electrical data (at T_{amb} 20 °C)

Contact resistance \leq 5 m Ω
 Rated current 10 A (T_{amb} 70 °C)
 Rated voltage 250 V AC
 Material group IIIa (IEC)/2 (UL) (CTI \geq 250)
 Creepage distance 3,5 mm
 Clearance 3,5 mm
 Insulation resistance > 10 G Ω

Associated products

Counterparts

 3618	 3618-1	 3618-2
 3618-3	 361899	 361899-1
 361899-2	 361899-3	 3641
 364199	 3642	 364299
 3643	 364399	 3644
 364499	 3645	 364599

3647	3648	3649
3671	367199	3672
367299	3673	367399
3674	367499	3676
3677	3678	3679
3680	3683	

36

3615

Designation	Pole Number	PU (Pieces)	MDQ (Pieces)	Dimensions		
				A (mm)	B (mm)	unbenutzt (mm)
3615 02	2	200	1000	5.0	9.9	-
3615 03	3	200	1000	10.0	14.9	-
3615 04	4	200	1000	15.0	19.9	-
3615 05	5	200	1000	20.0	24.9	-
3615 06	6	200	1000	25.0	29.9	-
3615 07	7	200	1000	30.0	34.9	-

Designation to be completed by further details (e.g. for keying, color or material options).

Packaging:

in bulk, in a cardboard box