



ELECTROTECHNICAL
PRODUCTS
2024/2025

CATALOGUE



NEW



IDEALNA
SZYBKOZŁĄCZKA



page 49



MULTI
Multiwall[®]
Multipole junction boxes

page 99



NSW90x90
Surface junction boxes

page 117



HAD02
Surface junction connecting box
for the kitchens

page 124



WU60
Windproof insert
for junction boxes

page 132



SE2x60G



SE2x60D



Flush-mounted junction boxes for electronics

Your electronics in good hands

p. 100

PV60G



p. 101

ZV60GFw



p. 94

Extra deep boxes 80 mm

HAD02



Junction box for kitchen fittings HAD02

p. 124

SIMBLOCK®

STB 16



STB 35



Rail-mounted screw terminal blocks
STB 16 mm² and 32 mm²

p. 40

SIMBLOCK®

SCB 25-2



p. 60

SCB 70



p. 59

Branch distribution blocks SCB

WU60



Windproof insert for boxes

p. 132

Busbars

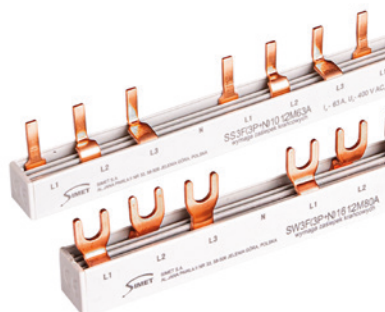

p. 143

FASTRING®

S60DFw



Mounting ring PM-85

p. 132

	Pictograms	6
I	BUSINESS ACTIVITY OF SIMET S.A.	7
1.1	Multibox - multi-solution for installers	13
1.2	Flush-mounted junction boxes Multiwall , MultiwallSlim	16
1.3	Series Fastbox&Hook	18
1.4	Junction boxes for mounting electrical devices SE2x60D, SE2x60G	19
1.5	Simblock - Rail-mounted screw terminal blocks and distribution blocks	20
1.6	Thermoplastic screw connector strips	22
1.7	Wire connector Idealna	24
II	TERMINAL BLOCKS	25
2.1	Rail-mounted screw terminal blocks	26
2.1.1	Nowa Series	26
2.1.2	Standard Series	28
2.1.3	For special applications	30
2.1.4	Protective	32
2.1.5	Accessories for rail-mounted terminal blocks	34
2.1.6	Simblock - STB Series	39
2.2	Porcelain - CPO Series	45
III	WIRE CONNECTOR	49
3.1	Wire connector Idealna	50
3.2	MINI Series	54
3.3	Twist connectors	55
3.4	Other assortment	56
IV	DISTRIBUTION BLOCKS	57
4.1	Simblock - Branch distribution blocks - SCB series	59
4.2	Simblock - Distribution blocks - SDB series	63
4.3	Simblock - Universal distribution blocks - SUB series	65
4.4	ShNk distribution blocks (modular)	68
V	BRANCH TERMINALS	71
5.1	Branch terminals	72
5.2	Distribution connectors	77
VI	CONNECTOR STRIPS	79
6.1	LTF orange series	80
6.2	Standard series LTA, EKL5E	82
6.3	One-side closed series, through LTA	85
6.4	LTT holders for TS 35 rail	88
VII	JUNCTION BOXES	89
7.1	Flush-mounted junction boxes	90
7.1.1	Standard	90
7.1.2	Multiwall multi-pole	96

7.1.3	MultiwallSlim multi-pole	99
7.1.4	4 For electronics	100
7.1.5	For wall lights	100
7.2.	For cavity walls	101
7.2.1	Standard	101
7.2.2	Multi-pole Multibox K , Multibox 2	104
7.2.3	With membranes, windproof	107
7.2.4	For wall lights	108
7.2.5	Fire protection, BS series	109
7.3	Surface	110
7.3.1	IP20, IP44	110
7.3.2	IP54, Fastbox&Hook	112
7.3.3	IP54	115
7.3.4	IP55 - NSW series with 1 screw	117
7.3.5	IP67 - air-tight housing SOH	118
7.4	Fire protection PIP	120
7.5	For special applications	123
7.5.1	For channels with mounting on a TS 35 rail	123
7.5.2	For polystyrene walls	123
7.5.3	Junction boxes for kitchen fittings HAD01, HAD02, junction box for wooden house PDD60	124
7.6	Equipment for junction boxes	125
7.6.1	Membrane grommets, tightening membranes	125
7.6.2	Connectors, downlight cover, spacer screws, spacer rings	127
7.6.3	Signalling covers, spacer rings, gel	129
7.6.4	Covers	130
7.6.5	Mounting ring Fastring , windproof, insert WU60 i cutter NS	132
VIII	MODULAR APPARATUS	133
8.1	Simtec varistor surge arresters	134
8.2	Simlic digital electricity meters	141
8.3	Voltage indicators SWN 3F Plug socket for installation on a TS rail - MRD50-16	142
8.4	Fork and pin type busbars	143
IX	OTHER ASSORTMENT	145
9.1	Cable glands	146
9.2	Indicator lights	147
9.3	Earthing bands, gel joints MiniGelBox , insulated clamps - Simblock - SBB series	149
9.4	Rail clamps	150
9.5	Equipotential strips, cable holders, rail insulator	151
9.6	Flops, cable holders	152
9.7	V-clamp	154

SALES DEPARTMENT OF SIMET

Maciej Waszak
Commercial Director



DOMESTIC SALES

The product sales are conducted based on the Sales Department of SIMET. Sales Department's structure includes 5 regional representatives, who maintain commercial relations with domestic recipients.

I area (Pomerania) Szczecin, Koszalin, Słupsk, Gdańsk, Elbląg, Gorzów Wlk, Piła, Bydgoszcz, Toruń	Marcin Poździak +48 502 496 652 region1@simet.com.pl	III area (West) Zielona Góra, Poznań, Leszno, Jelenia Góra, Legnica, Wrocław, Kalisz, Wałbrzych	Jakub Kacpura +48 502 496 655 region3@simet.com.pl
V area (Center) Włocławek, Płock, Konin, Warszawa, Sieradz, Łódź, Olsztyn, Suwałki, Ostrołęka	Jakub Raniszewski +48 502 496 656 region5@simet.com.pl	VI area (South) Opole, Częstochowa, Katowice, Kraków, Bielsko Biała, Gliwice, Chorzów	Maciej Wróbel +48 502 496 653 region6@simet.com.pl
VII area (East) Whitestok, Siedlce, Biała Podlaska, Lublin, Kielce, Zamość, Tarnów, Rzeszów, Przemyśl, Nowy Sącz, Radom	Mateusz Czarnecki +48 502 496 651 region7@simet.com.pl		

EXPORT

Service for our foreign customers is provided by the Foreign Trade Department

Monika Simon
+48 75 64 71 481, +48 502 496 654
smonika@simet.com.pl
Support in English and French

Monika Mularczyk - Kotarba
+48 75 64 71 470, +48 607 700 354
mmonika@simet.com.pl
I Support in Russian

TECHNICAL CONSULTING

Piotr Stawski
+48 512 978 402
doradcatech@simet.com.pl

Pictograms

Pictograms									
Type of material	PA 6 polyamide	PA 66 polyamide	PE polyethylene	PP polypropylene	PPS polyphenylene sulphide	TPE thermoplastic elastomers terephthalate	PS polystyrene	PC polycarbonate	PBT polybutylene
Material properties	fire resistance	halogen-free	self-extinguishing	flame retardant	UV	UL94 V0 flame rating			
IP rating	IP 20	IP 30	IP 44	IP 54	IP 55	IP 65	IP 66	IP 65/67	IP 67
Certificates, declarations, standards, tests									
			IFPILM INSTYTUT FIZYKI PLAZMY I LASEROWEJ MIKROSYNTEZY						

Pictograms							
Rated current	Power	Voltage	Operating temperature	Ambient temperature	Dimensions	Collective packaging / standard	MEGA collective packaging // Quantity in large collective packaging SIMBLOCK
Mounting	Number of /- phase /- neutral /- protective	MSUB connecting bridge	Rated cross-section	Cross-section-stranded wire with ferrule	Number of measurement connectors	Number of conductors per pole	Compatible with mounting ring PM-85



ELECTROTECHNICAL EQUIPMENT PRODUCER

As a leading Polish producer of electrotechnical equipment, we have devoted the last 50 years of our activity to providing all installers with the products that meet high standards applicable in the world of electrical engineering.

"We want to facilitate the work of installers by supplying to the market the products that are characterised not only by Excellent quality and precise workmanship, but also by exceptional ergonomics and ease of use."



RESEARCH AND DEVELOPMENT DEPARTMENT

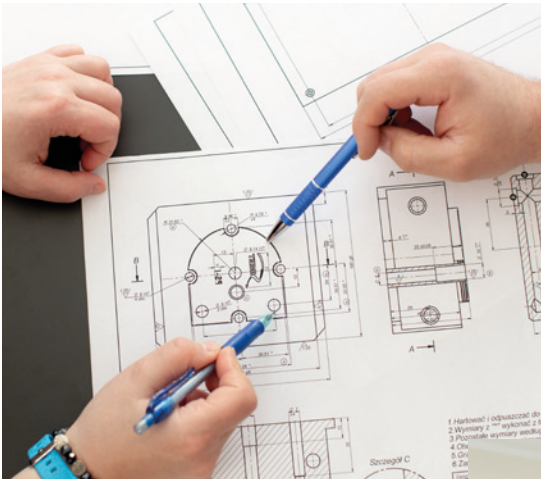

SIMET puts great emphasis on the improvement of its own products as well as introduction of new products, which are developed from scratch in our plant in Jelenia Góra.

Our R&D Department develops designs, creates prototypes using up-to-date NX CAD and NX CAM software. At the same time, we cooperate with scientific centers in order to systematically improve the qualifications of SIMET S.A. employees and keep up with the innovations of the constantly changing electrotechnical market.

Experienced engineers are engaged in continuous improvement of our products and introduction of new solutions. Our know-how and determination to be a leader in the electrical industry means that we are always ahead of the needs of installers and make it easier for them to work with our products, especially the junction boxes, of which we are very proud.





MODERN MACHINERY PARK



Our main production activity is the manufacture of plastic and metal products for the electrical engineering industry.



With our high-end machinery park, in particular several dozen hydraulic and electric injection moulding machines and automatic assembly lines, we can implement the most innovative ideas to meet the needs and requirements of our customers and people operating with our products.





OWN TOOL SHOP

The production support is provided by our own tool-shop, which is mainly used for the production and servicing of moulds used in the processing of plastics. With own tool shop, SIMET S.A. has unlimited control over the entire design and production process. We have years of experience that protects us from unnecessary time wastage and allows us to avoid mistakes. Our employees are a repository of knowledge from the creation of the injection mould and tools to the production of the final product.



WAREHOUSE INFRASTRUCTURE



Modern warehouse infrastructure, e.g. a silo for plastics and a high-class warehouse management system, allows to control the production and logistics processes, as well as to quickly respond to changing needs of the market.

The available area allows for optimal stock management.

SIMET S.A. operates in modern production halls with a total production and warehousing area of 17,100 m², located by the main thoroughfare of Jelenia Góra.





INTERNATIONAL COOPERATION

SIMET S.A. is also involved in extensive cooperation activities.

For many years, we have been cooperating with other domestic and foreign companies to supply our partners with plastic and metal components for their own production.

We have built our know-how with major international companies from both Europe and all over the world, particularly in the automotive sector.



We are looking forward to working with you

logistyka@simet.com.pl

+48 75 64 71 435

We are not only the leading manufacturer in the electrical engineering industry in Poland, but we have also been cooperating for years with other domestic and foreign companies to supply plastic and metal components for their own productions.

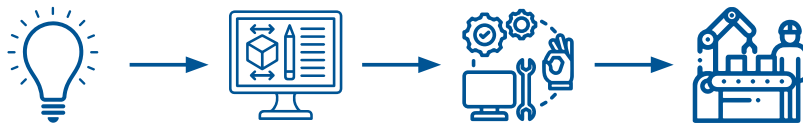

YOUR IDEA - OUR TASK

We are equipped with the tools and expertise to implement your idea from concept to final product. Tell us what your expectations and needs are, and our team will provide a comprehensive service at every stage of implementing your idea.

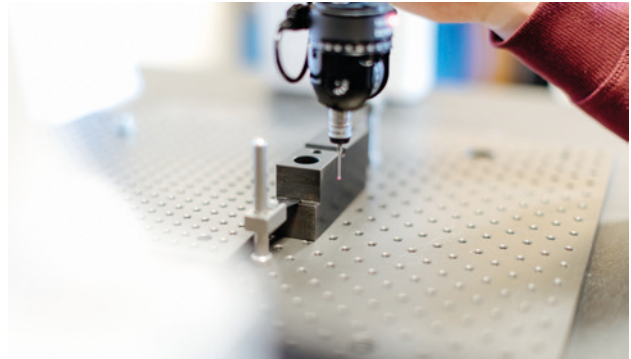
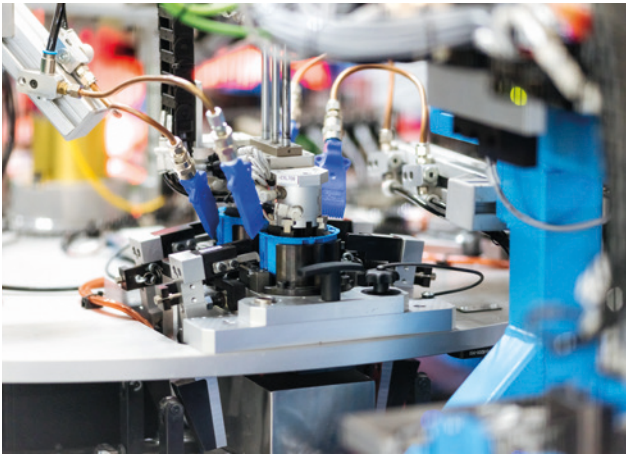

PRODUCT DESIGN

Our team of experienced engineers will create your product from scratch.

Supported by its experience and state-of-the-art NX CAD and NX CAM software, the Design and Research Department develops the design, creates the prototype and simulates the injection moulding. This eliminates any defects right from the design stage, saving time and money during series production.

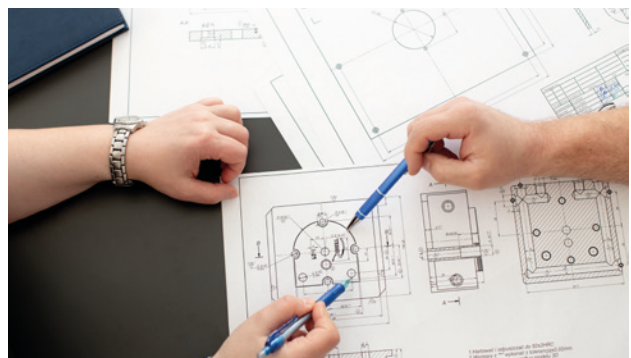
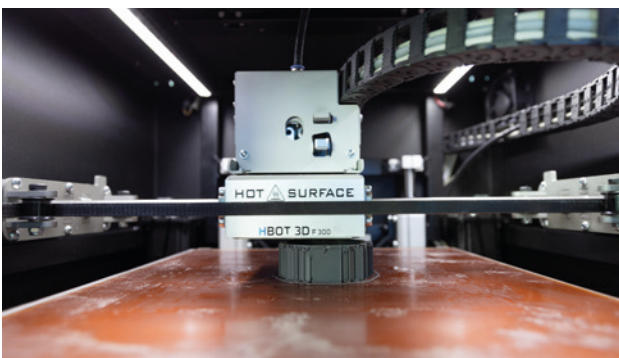
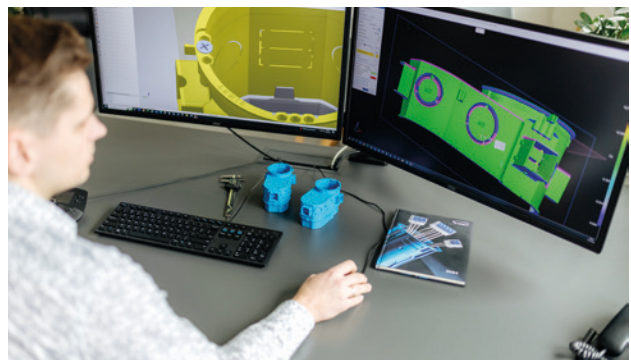



TOOL PRODUCTION



We have a significant advantage in the market as we have our own tool shop, which is capable of creating the tools, in particular the injection moulds necessary for the production of various plastic components, on its own. The tool shop is equipped with modern CNC machines, including milling and hollowing stations, wire hollowing machines and other advanced machine tools, which allow us to make complex tools in-house. With our own tool shop, we are able to flexibly adapt to the individual needs of our customers. **In addition, it enables us to ensure timely delivery**, as we respond quickly to any technical problems by providing an immediate and professional service, with no reliance on external companies.

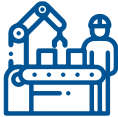

PRODUCTION START-UP

Our plant, equipped with state-of-the-art machinery, is perfectly prepared for the serial production of various plastic and metal components. We have dozens of hydraulic and electric injection moulding machines, automatic assembly lines and qualified employees, ensuring a comprehensive production process. In order to ensure the highest possible quality and safety of your products, they are constantly inspected. Our quality department has an internal laboratory where it tests, evaluates and improves the products we manufacture. In addition, our Integrated Quality and Environmental Management System, implemented and certified by TÜVNORD, based on the ISO 9001 and ISO 14001 standards, guarantees the highest standards in the production process and, ultimately, directly translates into product quality.

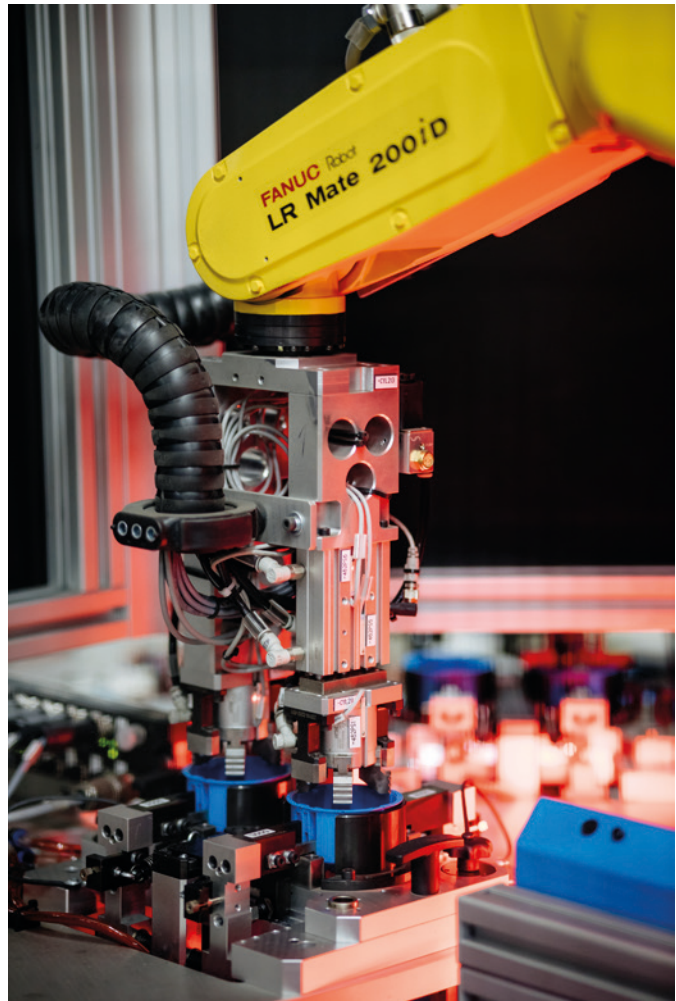

SIMET S.A. - Your partner in the implementation of the most demanding projects.

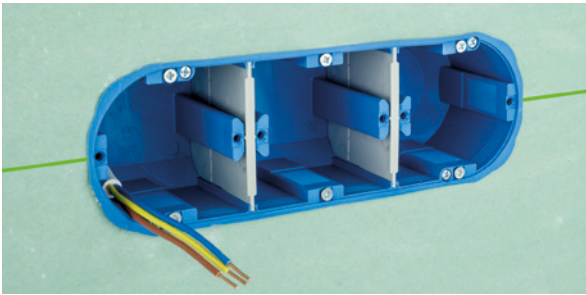

MULTIBOX®

Multi-solution for installers



SIMET S.A.'s offer includes a wide range of multi-pole junction boxes for cavity walls, which ensure connections, as well as protection of electric and teletechnical conductors. The Multibox series products constitute an excellent solution for installers and they are intended for installation in cavity walls, both thick (series of deep junction boxes Multibox 2) and thin ones (series of shallow junction boxes Multibox K). SIMET S.A. has **registration certificates** at the Patent Office of the Republic of Poland for both the original (**NO. 20557**) and modernised (**NO. 28987**) versions of the Multibox series of boxes.

The Multibox junction box series will be especially useful in electric installations mounted in the OSB and plasterboards. Due to the fact that installations in cavity walls are encumbered with the risk of ignition and spreading of fire, the bodies of junction boxes are made of PA6 polyamide, i.e. self-extinguishing and halogen-free material. The compact and flexible structure of the Multibox junction box easily adapts to the mounting hole. Numerous knockouts at the bottom enable easy and convenient routing of cables, pipes or conduits. The series is valued on the market due to safety of use, functionality, as well as aesthetics.

More space

Changed structure of the body, along with the use of a new type of hooks provided the possibility to enlarge the space inside the box, while maintaining almost the same external dimensions. The new branching routing system under mounted fittings requires more space, so these junction boxes had to face this challenge. In total, the internal dimensions of Multibox 2 increased by approx. 20%, providing not only convenience, but also new installation possibilities.

More functionalities

Unlike its predecessors – the idea of these junction boxes is based on retractable partitions that separate the individual installation poles. They fulfil an insulating function, which is justified by the need to separate electric parts from electronic parts, and they also improve the stiffness of the structure. In the lower part, these partitions include knockouts for routing conductors and connections running at the level of the box bottom. Modernised bottom of the junction box makes it easier to cut holes for conduits and installation pipes. Moreover, it is also possible to connect adjacent boxes with the use of $\varnothing 16\text{mm}$ and $\varnothing 20\text{mm}$ pipes in Multibox2 and $\varnothing 20\text{mm}$ and $\varnothing 25\text{mm}$ pipes in MultiboxK.

Hooks with a new design allow for the mounting of boxes to the walls with very small thickness of the structure – even millimetre thickness (made of sheet metal or plastics).



Multi-pole junction box MULTIBOX 2 – deep

Greater versatility

Junction box versatility is a feature that allows it to be used in individual, often significantly different from the standard ones, installation conditions. The Multibox series provides the possibility of equipping it with box accessories included in the SIMET S.A. offer, which allow to obtain new installation applications.

The main innovation increasing its versatility is adaptation to the function of branching junction box, in its entirety or in part, i.e. closing its interior with closing covers (PM1 or PM2). This feature is often useful for jointly placement of electronic, electric and IT devices in the body of the junction box. Moreover, it is possible to use connection covers in it – PKS60. They are intended for routing the conductors out of the enclosed space of the junction box (e.g. for direct connection of electric installation of kitchen fittings to the built-in installation – equipped with wires without plugs).

More satisfaction

The **Multibox** series is a reason for SIMET S.A. satisfaction and contentment of the installers. The previous series proved successful and generated significant sales, as well as constituted an important position in the development of SIMET S.A. products. We are proud of the new one, because we are sure that its innovative features will satisfy electric installers, as well as investors. These ideas were created not only on the drawing board, but also constituted a response to new practices and condition of electric installations. It is a combination of expectations emerging from electrotechnical, construction and partly IT industry.



Changed "columns" to fix fittings with "claws".



Undivided partition.

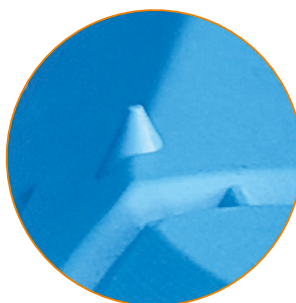

Changed position of marking pins for marking the drilling axis.

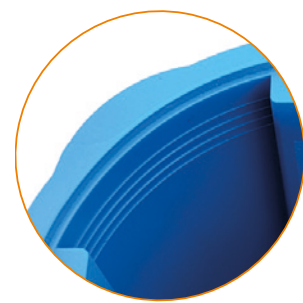

Wider flange for more secure seating in the mounting hole.



The Multibox series is the quintessence of innovative solutions and just like before, it does not disappoint – offering new useful electric installation functions. This innovative product has a special task to carry out – removing electric installation disarray behind the TV cabinets, i.e. minimising current splitters on the floors and expanding the number of power outlets mounted in one installation block. Moreover, the version with a cover allows it to be used as branching junction box.

P6x60D

The P6x60D junction box for fittings is a continuation of the production line of Multibox 2 junction boxes for cavity walls. Our goal was to increase the number of poles in a multi-track box over five. Limitations regarding the design of this junction box resulted from the fact that most of the connector and socket manufacturers did not have 6-pole frames in their offer. The solution is to use two 3-pole frames, which are placed one below the other. In order to ensure proper installation of the fittings, a special internal partition is applied between these frames, which cover the clearance between them, so that most frames from various manufacturers can be freely installed in these boxes. This junction box allows for compact (block) embedding of many sockets directly in the wall, without the need for using unaesthetic branching in extension cords or current splitters. The number of used various installation sockets has increased in the recent years due to the use of many connections. In addition to the electric sockets, also the IT, TV, speaker and antenna sockets are used. Similarly to the entire series of



Multibox 2 junction boxes, this one is also made of self-extinguishing halogen-free material. For demanding installers and modern customers, this product faces new challenges such as electric installation in smart buildings.



Multibox2 - P6x60D

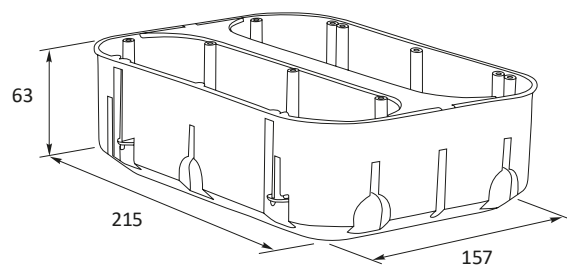

P6x60DP

The P6x60DP junction box is the second version of the P6x60D junction box for fittings. This one has a completely different application and due to that fact, it has no internal partition, however a cover closing

its interior was added. The electrotechnical task of this junction box is to obtain a large space in the plasterboard for embedding electric or electronic elements.



Multibox2 - P6x60DP

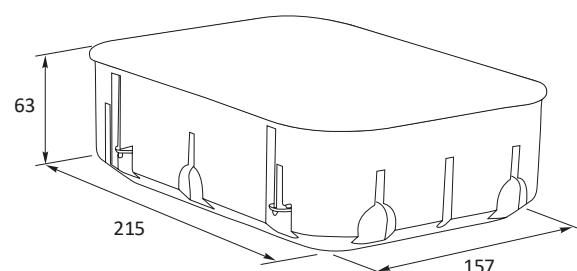







Multiwall®

Multiwall Series – the series of multi-pole flush-mounted junction boxes. It consists of six junction boxes: 2-, 3-, 4-, 5-, 6-pole junction boxes, respectively. The idea for these boxes originates directly from the groundbreaking series of multi-pole boxes for cavity walls named Multibox. Multi-polarity, i.e. enclosing a box intended for embedding several pieces of hardware elements in one solid block, has already established itself on the Polish market and such phenomenon decided about the new series' success.

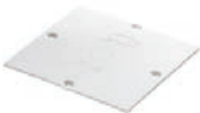

Interior - as a standard, these junction boxes are equipped with retractable partitions with knockouts implemented in the end sections in order to allow for routing wires in their lower part, which connect individual elements embedded in the box. The partition extension option was used to facilitate access to the lower part of the junction box, where wires can be routed or, if not needed, the partition can simply be removed.

Accessories for the junction boxes of Multiwall series

PS1 	PM1 	PDM60Z 	PD60x30 
PS2 	PM2 	PDM60W 	PKS60 

PS series signalling covers and PM series covers complete the accessories by making the series fully usable, just like the accessories in single-pole junction box.

Multiwall^{SLIM}®

The **MultiwallSlim multi-pole box series** is designed for flush-mounted installation. It consists of four boxes with 2, 3, 4, 5 poles. Due to the variety of knockouts in the body of the box, the inner surface of the box can be conveniently exposed, both when using pipes and conduits for installation and when directly feeding wires into the body of the box.



Advantages of the MultiwallSlim series

RIBS
The rigid body is reinforced with ribs, which stabilise the box structure.

KNOCKOUT
Knockout on the sides of the box to facilitate seating and installation.

ENLARGED MARKERS
Larger markers in the bottom for the insertion of the mounting foam and for marking the drilling points on the wall.

SEATING MARKER
10mm and 15mm box depth embedment marker.

COLUMNS
Wider surface for mounting fittings vertically or horizontally with „claws“.

KNOCKOUTS
New location of knockouts in the bottom of the box for inserting wires and cables.

Accessories for MultiwallSlim series boxes

<p>PS3</p>	<p>PM1</p>	<p>PDM60Z</p>	<p>PD60x30</p>
<p>PS4</p>	<p>PM2</p>	<p>PDM60W</p>	<p>PKS60</p>

FASTBOX® & HOOK

Fastbox&Hook products consist of surface junction boxes, which have been specially designed for the installation on cable routes. This series of boxes is innovative in terms of mounting technology. It includes the following junction boxes: NS5, NS6, NS7, NS8, NS9 and HNS hook. Their body is made of polyethylene (PE). The self-latching polypropylene (PP) cover makes the body of the junction box rigid when closed. The hook is made of polyamide (PA6). The junction box's bottom includes two openings for inserting hooks, which allow easy installation of the junction box on the cable tray. Quality of these junction boxes has been confirmed by the positive results of tests carried out by the accredited national certification body for electrical products – Quality Research Office (BBJ). As a result of the above-mentioned innovative technology, the installation using the HNS hook is an added value, compared to the previous series of Fastbox junction boxes.

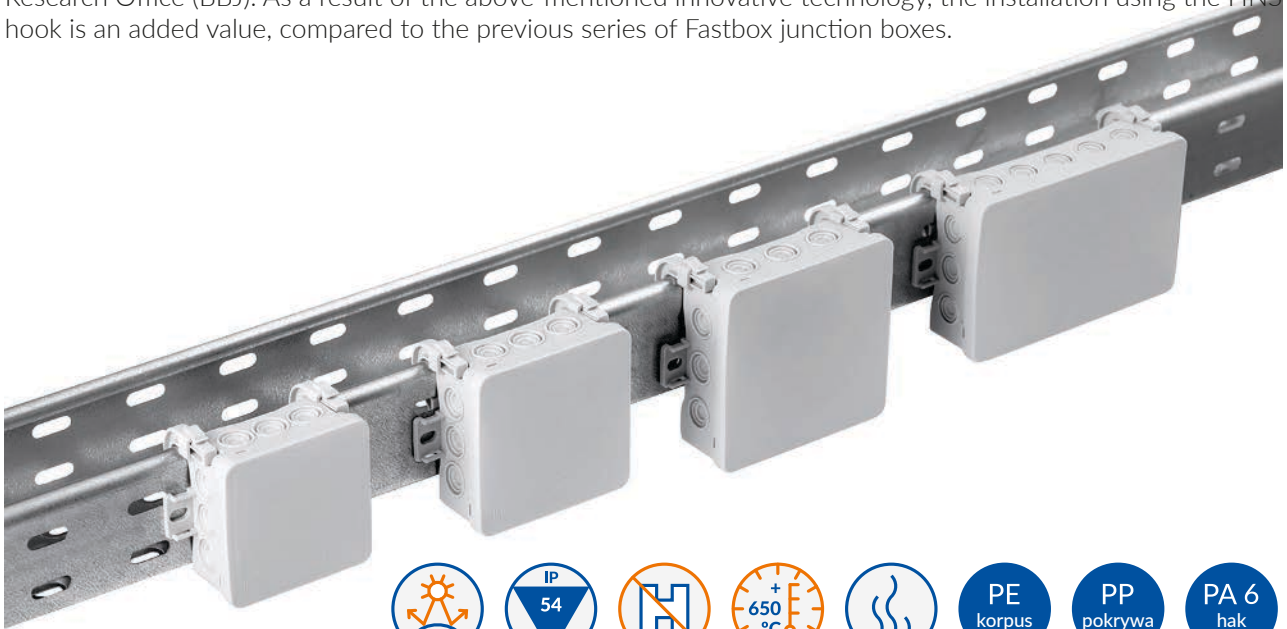

Installation on a cable route with the use HNS hooks takes less than 10 seconds.



An innovative method of installation with the use of hooks, which is reserved in the patent office.

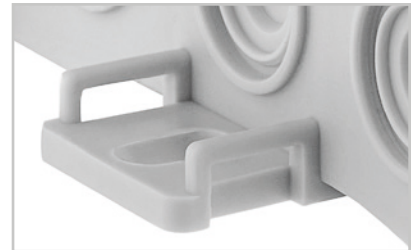

Bracket for mounting with the use of bands or screws (Ø 6mm) that facilitate the installation.



The self-locking cover is made of polypropylene. Its smooth surface allows for placement of the description of the installation.



One central knockout in the NS8 box.



Cutter for knockouts.



Junction boxes in five colours.



Good value for money.



Quality confirmed by positive results of tests carried out by the BBJ.

SE2x60D



SE2x60G



SE2x60D and **SG2x60G** junction boxes are adapted for embedding specialised electric and electronic devices. Specially widened interior of these junction boxes provides the possibility of placement of additional elements, e.g. control elements, in addition to the fittings mounted on the flange. It is possible to use the entire space of the box for only electronic, electric or control elements and closing them with the PL60 cover. These junction boxes are characterised by serial structure, which allows them to be connected to each other from any given side. The structure of these boxes consists of two separate elements connected via latches.

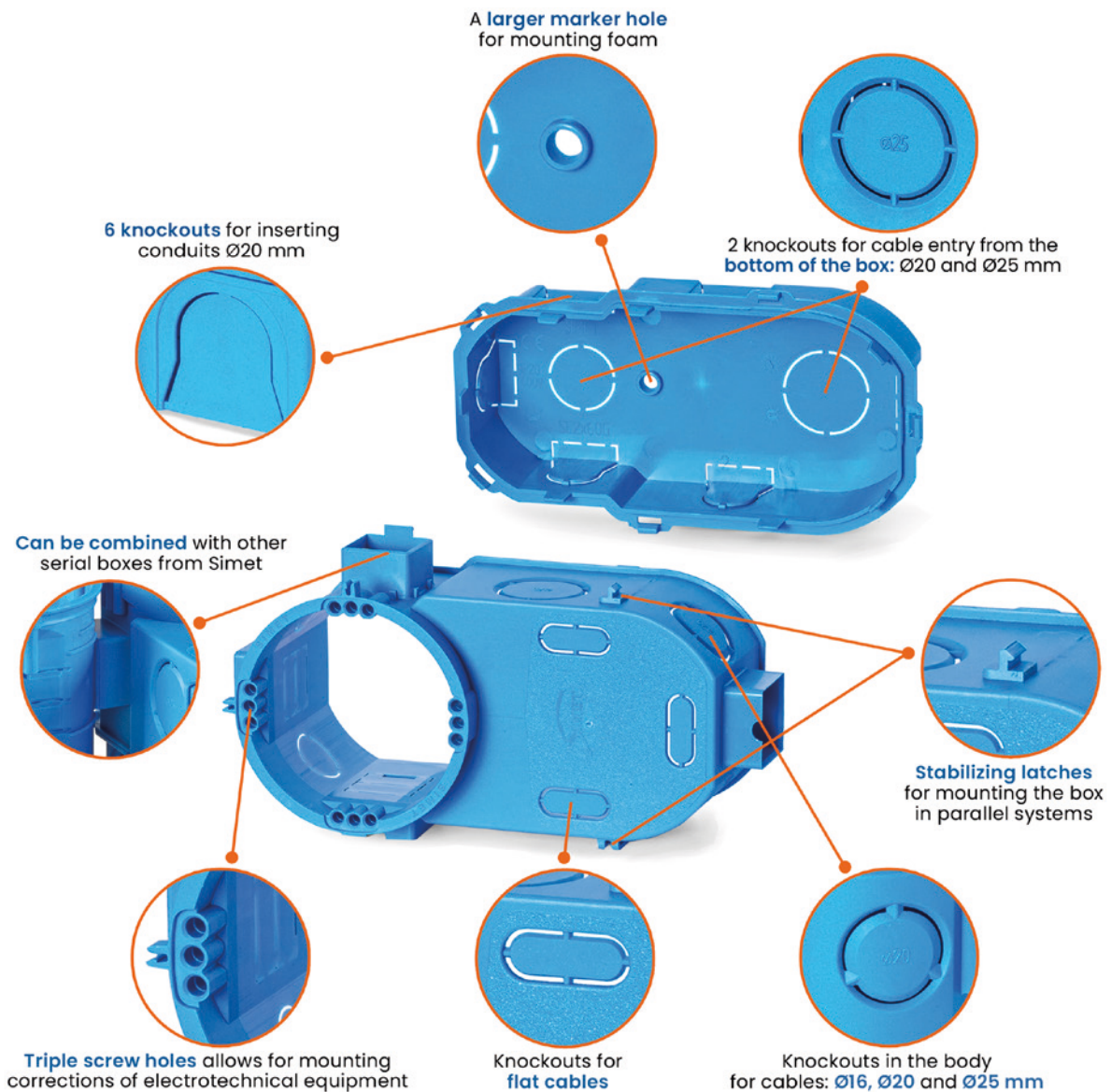

SIMBLOCK®



SIMBLOCK

New quality of wire connection from SIMET S.A.

SIMET S.A. in cooperation with a German electrical engineering manufacturer has introduced a new category of threaded connectors and distribution blocks for the connection of aluminium and copper conductors onto the Polish market under the Simblock brand. This type of connection is now popular in many industries. The Simblock product brand is used in the construction industry, in machine building, in the automation of production processes, in electrical switchgear and in equipment producing electricity from renewable sources.

Simblock stands for secure, durable and safe electrical cable connections.

STB rail-mounted screw terminal blocks

The use of STB series products from 16 mm² to 300 mm² allows for connection of the wires characterised by cross-sections from 6 mm² to 300 mm², as well as the wires equipped with end sleeves from 4 mm² to 240 mm². The exceptional structure of these terminal blocks improves the functioning of electrical connections. The unique shape of the core, as well as the special corrugation of the body result in the fact that heat generated during the terminal block's operation is not accumulated, but discharged to the outside. High standard of the Al/Cu connections is guaranteed by the UL 486E certificate. Due to thicker walls of the housing, the terminal block does not deform during tightening of the wires and it is stable on a TS 35 rail. The hex key screws equipped with fine thread increase the clamping force. The colours of body cover (grey/ blue / green / brown / black) refer to the actual colours of connected wires. An exceptional characteristic of the STB from 95 mm² to 300 mm² is the additional area in its structure for the so-called measuring connector. It provides the possibility to control the status of wire connection in specific location, and to monitor the whole installation. Shape of the housing of each STB terminal block guarantees protection of the installer's hand. The entire aesthetic appearance of the STB is completed with a dust cover (OSTB), which includes a special place for the marking (L1, L2, L3, N, PE).



Al/Cu STB 95 SIMBLOCK Rail-mounted screw terminal blocks

SIMBLOCK®

SDB distribution blocks and SUB universal distribution blocks

SUB has a special place in the entire Simblock category. This series includes products with input cross-sections from 2,5 mm² to 185 mm² for the solid-core wires as well as stranded-core wires, and from 1,5 mm² to 150 mm² for the wires equipped with end sleeves. This provides an unlimited possibility to connect wires characterised by various sizes and shapes. The advantage of these blocks is their ergonomic shape and unique structure. The SUB has been designed in a manner adapted to the inner shape of the installer's hand. Its gentle rounded edges facilitate manual work during installation of wires and protect the installer against unwanted contact with the active part of the core. The transparent SUB cover allows for the inspection of each of the connected and distributed wires. Numerical and letter markings intuitively guide the installer between the input and output channels. At the same time, the SUB includes special places prepared for the purpose of implementing connections with round and flat wires.

With the use of lateral hooks, each SUB may be connected to the adjacent block in order to create a section, in any given order and regardless of the size, and it provides the possibility of bridging them. This may be implemented with the use of round wires, as well as specially insulated flat bridges. An additional advantage is the brass core adapted to operation with a voltage of 1000 V AC / 1500 V DC, which is particularly important in the locations, in which greater loads of the network occur. On the other hand, the SDB series has been designed to distribute power in small switchgears and control cabinets. The SDB series includes blocks with input cross-sections from 2,5 mm² to 70 mm² for the solid-core wires as well as stranded-core wires, and from 1,5 mm² to 50 mm² for the wires equipped with end sleeves. In the cases, in which wires with smaller cross-sections are used and in which a lower current intensity occurs, the SDB successfully fulfills its function. The SDB 100 may be mounted horizontally as well as vertically, while the lateral hooks allow to create sections on the TS 35 rail in any given order.

SCB branch distribution blocks

SCB is a very significant distribution block, which should be used by the installer when connecting power cables, both in devices and facilities. In the case of this product, there is a possibility to connect the wires from 2,5 mm² to 70 mm², as well as the wires equipped with end sleeve from 1,5 mm² to 50 mm². The characteristic that distinguishes the SCB blocks from all other similar products on the Polish market is its width. In the case of the SCB 25, its width amounts to only 17,8 mm. This dimension, when calculated for the length of the standard TS 35 rail, used in the connection cabinets and switchgears, provides the possibility of installing more SCBs in series. This is particularly significant in the scope of using the space intended for branch distribution blocks in the area of every electrical cabinet. As a result, the installer has more possibilities to freely route the wires. Another advantage is the durability of terminals intended for locking of the wires in the SCB core. Every wire introduced into the SCB is secured with the use of two set screws. By using an appropriate screwdriver, it is possible to achieve durable fixing of the wire with a specific cross-section in the innovatively constructed core. Structure of the SCB housing prevents the screws from falling out. All SCBs are characterised by the possibility of being combined into sections, while the 3-, 4- and 5-pole SCBs may be additionally installed in horizontal as well as vertical position. Such positioning possibility of SCB in the connection cabinets and switchgears will be appreciated by every installer encountering some spatial limitations during conducted installation works. Branch distribution blocks may also be used by the distributors and owners of power grids during implementation of connections in the facilities.



Al/Cu SUB 220 SIMBLOCK universal distribution blocks



Al/Cu SCB 25-5X SIMBLOCK branch distribution block

Thermoplastic screw connectors strips are a traditional electrotechnical product used in connection technology. Almost 30 years of production experience, as well as our high position on the Polish and European market place make us the leader position in this range of products. These products are used to connect wires in junction boxes, lighting technology, cable-distribution cabinets and other common electric installation works.

“12-track products” are widely used in the scope of connecting single- and multi-solid wire conductors. The series manufactured by SIMET S.A. allows for connecting conductors in the range from 0,5 mm² to 35 mm². Currently, our range of products consists of five product series and accessories used with thermoplastic connector strips.

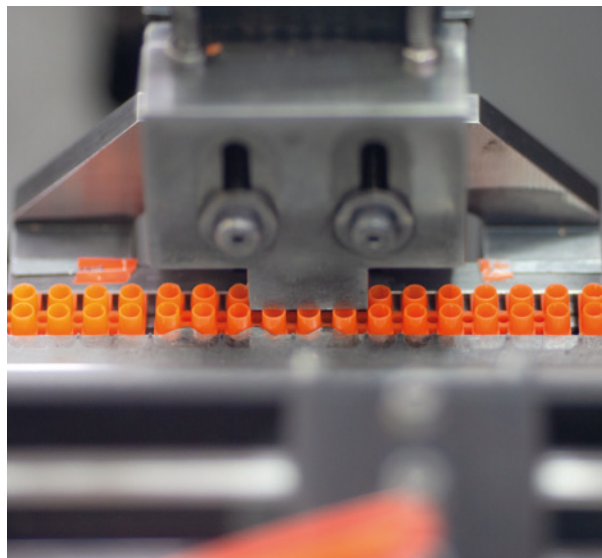

LTF orange series



These products are widely used in basic electric installation works. They are mainly applied in lighting technology, connections in junction boxes and other connections for low-voltage currents. Favourable price, exceptional ease of current circuit separation, as well as hand-friendly soft flexible body material are the main advantages of the series. The body is made of polyethylene, which provides the possibility of ease division of the terminal block into the desired number of current circuits with the use of mounting knife or by twisting the connector. The terminal block is equipped with holes that allow it to be attached to a substrate or a holder provides the possibility of its mounting on a TS 35 rail. The terminal blocks are equipped with solid brass current circuits and galvanised screws. Operating temperature: -40°C to +55°C.

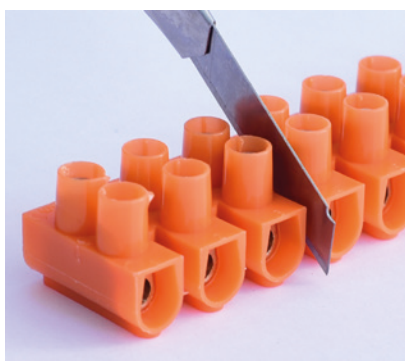

Easy separation for current circuits.

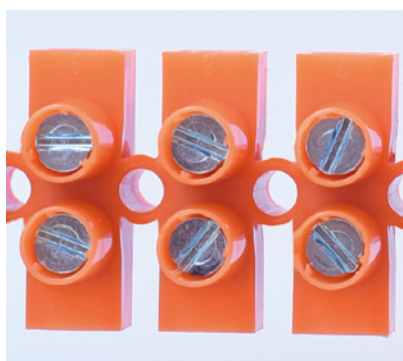

Holes that allow mounting to a substrate.



Rounded edges are convenient in use.

Standard LTA series - halogen-free material, Polyamide PA6

The standard series products are intended for industrial applications, especially where the quality of connection should be characterised by increased durability and higher resistance to weather conditions. Its distinguishing feature is the body material – Polyamide PA 6 and the covering of brass clamp with galvanic coating, which increases the resistance to corrosion. The plastic used in this product is characterised by the following properties: elasticity – resistance to cracks, good electric and mechanical properties (puncture resistance, resistance to creeping current CTI> 600, operating temperature from - 40 °C to + 85 °C, long-term operation at elevated temperature + 85°C), halogen-free material. Body material in the mounting holes has special grooves that improve division of terminal blocks into segments.



Easy separation into current circuits due to knockouts in connectors.



Clamps and screws covered by galvanic coating.



Polyamide PA 6 - halogen-free material.

Professional LPA series - halogen-free, self-extinguishing material, Polyamide PA 66

The series intended for professional applications manufactured in accordance with assumptions of the German VDE standard. These products are distinguished by the use of the best body material. It is polyamide PA 66, which is characterised by high operating temperature, as well as optimal mechanical and electric properties (puncture resistance, resistance to creeping currents CTI> 600, resistance to “thermal aging”, operating temperature from - 40 °C to + 125 °C, short-term peak operation at elevated temperature up to + 200 °C). The product is halogen-free - it does not contain silicone connections, PCB and dioxin.



Increased distance between the current circuits.



Clamps and screws covered by galvanic coating.



Polyamide PA66 - halogen-free, self-extinguishing material.

Series with a steel plate Polyamide PA66 - halogen-free, self-extinguishing material

Like the professional series, it is made of PA 66 polyamide and is generally similar to those fittings in terms of body and clamp features. The distinguishing feature is the use of a steel plate inside the clamp. The purpose of this plate is to provide pressure caused by tightening the conductor screw in such a manner that its structure is not damaged. These features are useful in the cases, where situations of temporary wire disconnection occur, or where there will be no possibility of clamp control during a longer period of time. This clamp is also useful in the case, when periodic forces acting on the conductor occur that can break it out of the terminal block. The conductor material is pressed there on a larger space and provides greater stability of the connected system.



IDEALNA[®]
SZYBKOZŁĄCZKA



Quick and safe installation.

According to current standards, the connection of low-voltage cables requires the use of suitable terminal blocks. Traditional terminal blocks and connectors involve the use of additional tools, thus making the connection inconvenient and time-consuming. Traditional cable connection techniques and methods are out of date, replaced by modern products such as lever wire connectors, push-in connectors and in-line connectors, which provide a faster, easier, safer and more consistent installation.

Electricians trust SIMET products because of their quality, innovation and unique advantages. We want to provide support to our customers according to the best standards. With this in mind, thanks to our partnership with Ideal Industries INC. we are introducing innovative products to the Polish market – wire connectors under the IDEALNA brand, which not only provide functional solutions, but are also practical, safe and durable. IDEALNA is a series of wire connectors that are halogen-free, compatible with conductors up to 4 mm² cross-section and 32 A current.



The SCL (Simet Connector Lever) series of wire connectors represent European quality in connecting single and multi-stranded wires from 0,2 to 4 mm² and from 0,14 to 4 mm² for cables. These are reusable connectors that do not require the lifting of a lever during assembly and, thanks to their innovative design and the material used (polycarbonate),

do not deform or break. The connection can be verified thanks to the transparent housing and the two built-in inspection ports. This series includes 2-way (SCL2), 3-way (SCL3) and 5-way (SCL5) wire connectors.

The SCP (Simet Connector Push-in) series is manufactured in the US and Japan. It is an ideal solution for rigid conductors from 0,75 to 4 mm² and for multistranded conductors from 1,5 to 2,5 mm². Push-in connectors reduce installation time by up to half compared to traditional screw connectors. The product's ergonomic and compact housing is secure and fits in the installer's hand. A current rating of 32 A is available for the SCP2, SCP3 and SCP4 product. The series also includes the 5-pole SCP5, 6-pole SCP6 and SCP8-hex connectors. For better identification, the products are marked with different colours.



An excellent choice for extending a connection or connecting two wires is the patented American SCS (Simet Connector Spliceline) series. The push-in installation, for single-wire conductors from 0,5 to 4 mm² and 1 to 2,5 mm² for multi-wire, without the use of tools makes installation extremely quick and easy. With its transparent polycarbonate housing with two inspection ports, the connection can be perfectly verified.

Some of the key benefits that result from switching from traditional cable connections to IDEALNA: SCL, SCP and SCS wire connector include: faster installation and excellent quality. Another advantage is that by using a lever or push-in connector, arc discharges, which can potentially cause a fire, are avoided. The biggest benefit is the time saving, which completely compensates for the higher cost of purchasing these products compared to traditional terminal blocks. By using this series of wire connectors, the consistency of the connection is also ensured, as there is no variation in the tightening of the fastening screw that fixes the cable in place. Products in this series comply with the standards: EN 60998-1, EN 60998-2-2, UL 486C, UL 467.

We have expanded our range with a number of wire connector kits consisting of SCL, SCP and SCS type connectors packaged in plastic boxes called COMBO. These kits meet the needs of today's electricians, who are looking for high-quality products and reliable cable connection in various applications (here and now, all in one, always at hand).



Now you can do more with the ideal wire connector from SIMET S.A.....

www.idealnaszybkozlaczka.pl

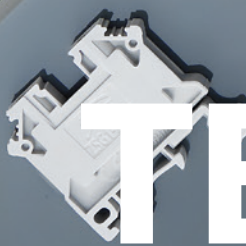
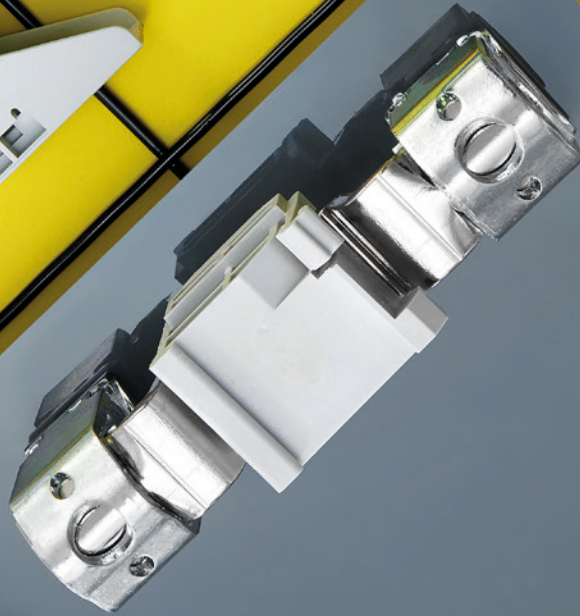
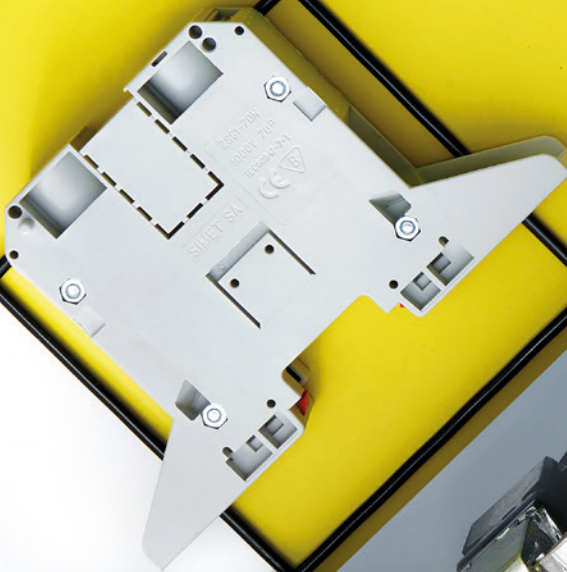
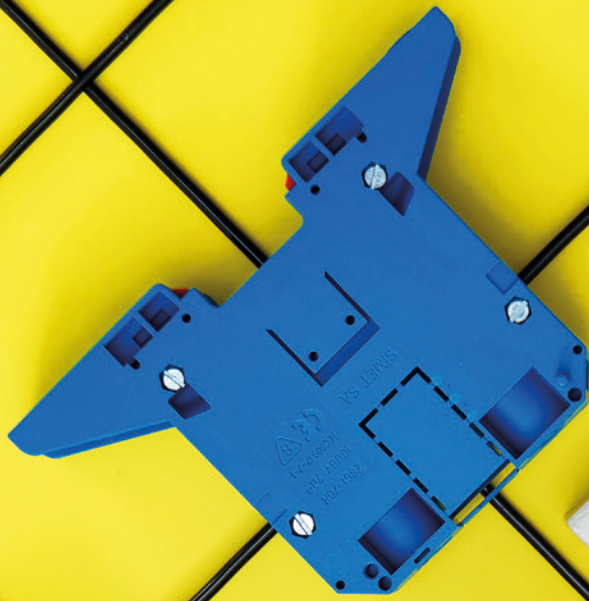

TERMINAL BLOCKS

2.1.1

RAIL-MOUNTED SCREW TERMINAL BLOCKS

NOWA series



NowA®

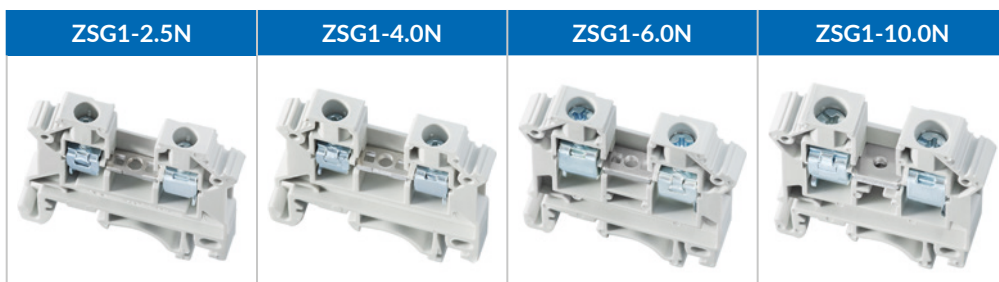
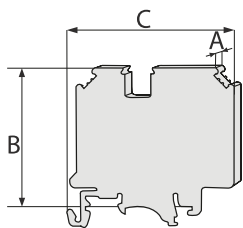

	ZSG1-2.5N	ZSG1-4.0N	ZSG1-6.0N	ZSG1-10.0N
	2,5 mm²	4 mm²	6 mm²	10 mm²
Colour Cat. No.				
Red ●	11 221 311 ●	11 321 311 ●	11 421 311 ●	11 521 311 ●
Grey ●	11 221 312 ●	11 321 312 ●	11 421 312 ●	11 521 312 ●
Blue ●	11 221 313 ●	11 321 313 ●	11 421 313 ●	11 521 313 ●
Yellow ●	11 221 314 ●	11 321 314 ●	11 421 314 ●	11 521 314 ●
Standard	PN-EN IEC 60947-1	PN-EN IEC 60947-1	PN-EN IEC 60947-1	PN-EN IEC 60947-1
Certificate / declaration	CE	CE	CE	CE
Rated cross-section	2,5	4	6	10
Solid wire	0,5 ... 2,5 mm ²	0,5 ... 4 mm ²	0,5 ... 6 mm ²	1,5 ... 10 mm ²
Stranded wire	0,5 ... 2,5 mm ²	0,5 ... 4 mm ²	0,5 ... 6 mm ²	2,5 ... 10 mm ²
Current data				
Rated voltage (max. impulse)	800 V / 6 kV	800 V / 6 kV	800 V / 6 kV	800 V / 6 kV
Rated current	24 A	32 A	41 A	57 A
External dimensions				
A / B / C [mm]	6 / 34 / 44	6,5 / 34 / 44	8 / 39,5 / 48	10 / 39,5 / 48
Set screw – bolt	M2,5	M3	M3,5	M4
Tightening torque	0,4 ... 0,6 Nm	0,4 ... 1,0 Nm	0,8 ... 1,6 Nm	1,2 ... 2,0 Nm
Stripped wire length	10 mm	10 mm	12 mm	12 mm
Mounting	on TS 32, TS 35 rail	on TS 32, TS 35 rail	on TS 32, TS 35 rail	on TS 32, TS 35 rail
Weight	6,6 g	7,5 g	13 g	17,3 g
Collective packaging	50 pcs	50 pcs	50 pcs	50 pcs

Optional equipment	Designation	Cat. No.	Col. pack.	Designation	Cat. No.	Col. pack.	Designation	Cat. No.	Col. pack.	Designation	Cat. No.	Col. pack.
Spacer												
Grey ●	T 928	17 928 302	50 pcs	T 928	17 928 302	25 pcs	T 929	17 929 302	25 pcs	T 929	17 929 302	25 pcs
End bracket												
Grey ●	T 910	17 910 312	50 pcs	T 910	17 910 312	50 pcs	T 910	17 910 312	50 pcs	T 910	17 910 312	50 pcs
Grey ●	T 940	17 940 312	50 pcs	T 940	17 940 312	50 pcs	T 940	17 940 312	50 pcs	T 940	17 940 312	50 pcs
Screw cross-connection												
2-pole	ZZ 2-2.5	18 221 128	10 pcs	ZZ 2-4.0	18 321 128	10 pcs	ZZ 2-6.0	18 421 128	10 pcs	ZZ 2-10.0	18 521 128	10 pcs
3-pole	ZZ 3-2.5	18 221 138	10 pcs	ZZ 3-4.0	18 321 138	10 pcs	ZZ 3-6.0	18 421 138	10 pcs	ZZ 3-10.0	18 521 138	10 pcs
4-pole	ZZ 4-2.5	18 221 148	10 pcs	ZZ 4-4.0	18 321 148	10 pcs	ZZ 4-6.0	18 421 148	10 pcs	ZZ 4-10.0	18 521 148	10 pcs
10-pole	ZZ 10-2.5	18 221 108	10 pcs	ZZ 10-4.0	18 321 108	10 pcs	ZZ 10-6.0	18 421 108	10 pcs	ZZ 10-10.0	18 521 108	10 pcs
Plug-in cross-connection												
2-pole	ZW 2-2.5	18 221 328	10 pcs	ZW 2-4.0	18 321 328	10 pcs	ZW 2-6.0	18 421 328	10 pcs			
10-pole	ZW 10-2.5	18 221 308	10 pcs	ZW 10-4.0	18 321 308	10 pcs	ZW 10-6.0	18 421 308	10 pcs			
Rail marker												
Grey ●	T 900	17 900 302	50 pcs	T 900	17 900 302	50 pcs	T 900	17 900 302	50 pcs	T 900	17 900 302	50 pcs
Grey ●	T 927	17 927 302	50 pcs	T 927	17 927 302	50 pcs	T 927	17 927 302	50 pcs	T 927	17 927 302	50 pcs
Marker												
		DK / Z5			DK / Z5			DK / Z5			DK / Z6	
								DK / Z6				

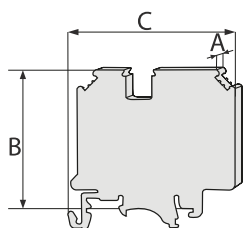

	ZSG1-16.0N	ZSG1-35.0N	ZSG1-70N	ZSG1-120N
	16 mm²	35 mm²	70 mm²	120 mm²
Colour Cat. No.				
Red ●	11 621 311 ●	11 721 311 ●		
Grey ●	11 621 312 ●	11 721 312 ●	11 951 312 ●	11 953 312 ●
Blue ●	11 621 313 ●	11 721 313 ●	11 951 313 ●	11 953 313 ●
Yellow ●	11 621 314 ●	11 721 314 ●		
Standard	PN-EN IEC 60947-1	PN-EN IEC 60947-1	PN-EN IEC 60947-1	PN-EN IEC 60947-1
Certificate / declaration	CE	CE	CE	CE
Rated cross-section	16	35	70	120
Solid wire	2,5 ... 16 mm ²	2,5 ... 35 mm ²	10 ... 70 mm ²	35 ... 120 mm ²
Stranded wire	2,5 ... 16 mm ²	2,5 ... 35 mm ²	10 ... 70 mm ²	35 ... 120 mm ²
Current data				
Rated voltage (max. impulse)	800 V / 6 kV	800 V / 6 kV	1000 V / 8 kV	1000 V / 8 kV
Rated current	76 A	125 A	192 A	269 A
External dimensions				
A / B / C [mm]	12 / 52,5 / 60	16 / 53 / 60	24 / 78 / 132	26 / 89 / 140
Set screw - bolt	screw type +/- M5x12	screw M6x12 / hex key 5 mm	Hex key 6 mm	Hex key 8 mm
Tightening torque	1,2 ... 2,0 Nm	2,5 ... 5,0 Nm	12 Nm	20 Nm
Stripped wire length	14 mm	17 mm	23 mm	26 mm
Mounting	on TS 35 rail	on TS 35 rail	on TS 35 rail	on TS 35 rail
Weight	33,8 g	55,7 g	179 g	280 g
Collective packaging	40 pcs	20 pcs	5 pcs	5 pcs

Optional equipment	Designation	Cat. No.	Col. pack.	Designation	Cat. No.	Col. pack.	Designation	Cat. No.	Col. pack.	Designation	Cat. No.	Col. pack.	
Spacer													
Grey ●	closed structure that does not require a spacer			closed structure that does not require a spacer			closed structure that does not require a spacer			closed structure that does not require a spacer			
End bracket													
	Grey ●	T 910	17 910 312	50 pcs	T 910	17 910 312	50 pcs	T 910	17 910 312	50 pcs	T 910	17 910 312	50 pcs
	Grey ●	T 940	17 940 312	50 pcs	T 940	17 940 312	50 pcs	T 940	17 940 312	50 pcs	T 940	17 940 312	50 pcs
Screw cross-connection													
	2-pole	ZZ 2-16.0	18 621 128	10 pcs	ZZ 2-35.0	18 721 128	10 pcs						
	4-pole	ZZ 4-16.0	18 621 148	10 pcs	ZZ 4-35.0	18 721 148	10 pcs						
Screw cross-connection													
	2-pole						ZZ 2-70.0	18 951 128	10 pcs	ZZ 2-120.0	18 953 128	1 pcs	
	3-pole									ZZ 3-120.0	18 953 138	1 pcs	
Rail marker													
	Grey ●	T 900	17 900 302	50 pcs	T 900	17 900 302	50 pcs	T 900	17 900 302	50 pcs	T 900	17 900 302	50 pcs
	Grey ●	T 927	17 927 302	50 pcs	T 927	17 927 302	50 pcs	T 927	17 927 302	50 pcs	T 927	17 927 302	50 pcs
Marker													
		DK / Z6			DK / Z6			DK / Z6			DK / Z6		

2.1.2

RAIL-MOUNTED SCREW TERMINAL BLOCKS

Standard series

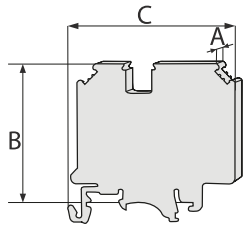

	lowered structure 16 mm ²	lowered structure 35 mm ²	70 mm ²
Colour Cat. No.			
Red ●	12 601 311 ●	12 701 311 ●	12 901 312 ●
Grey ●	12 601 312 ●	12 701 312 ●	12 901 313 ●
Blue ●	12 601 313 ●	12 701 313 ●	12 901 314 ●
Yellow ●	12 601 314 ●	12 701 314 ●	—
Standard	PN-EN IEC 60947-1	PN-EN IEC 60947-1	PN-EN 60998-1
Certificate / declaration	CE	CE	CE
Rated cross-section	16	35	70
Solid wire	2,5 ... 16 mm ²	2,5 ... 35 mm ²	10 ... 70 mm ² (with a cable lug)
Stranded wire	4 ... 16 mm ²	2,5 ... 25 mm ²	10 ... 70 mm ² (with a cable lug)
Current data			
Rated voltage (max. impulse)	800 V / 6 kV	800 V / 6 kV	800 V / 8 kV
Rated current	76 A	125 A	192 A
External dimensions			
A / B / C [mm]	13 / 41 / 48	14 / 44 / 58	41 / 61 / 88
Set screw – bolt	screw type +/- M5x12	screw M6x12 / hex key 5 mm	M8
Tightening torque	1,2 ... 2,0 Nm	2,5 ... 5,0 Nm	25 ... 30 Nm
Stripped wire length	12 mm	14 mm	29 mm
Mounting	on TS 35 rail	on TS 35 rail	on TS 35 rail + screw
Weight	27,0 g	50,5 g	179 g
Collective packaging			

Optional equipment	Designation	Cat. No.	Col. pack.	Designation	Cat. No.	Col. pack.	Optional equipment	Designation	Cat. No.	Col. pack.		
Spacer							Spacer					
	Grey ●	T 922	17 922 302	25 pcs	T 922	17 922 302	25 pcs		Grey ●	T 924	17 924 302	25 pcs
		T 925	17 925 302	25 pcs	T 923	17 923 302	25 pcs					
End bracket							End bracket					
	Grey ●	T 910	17 910 312	50 pcs	T 910	17 910 312	50 pcs		Grey ●	T 910	17 910 312	50 pcs
	Grey ●	T 940	17 940 312	50 pcs	T 940	17 940 312	50 pcs		Grey ●	T 940	17 940 312	50 pcs
Fixed cross-connection							Cover	Additional equipment				
	2-pole	ZW 62/T18	18 601 020	10 pcs	ZW 72/T19	18 701 020	10 pcs		Yellow ●	Cover ZP 200 (Item No. 89 926 004) 5 pcs		
	10-pole	ZW 61/T18	18 601 100	10 pcs								
Rail marker							Rail marker					
	Grey ●	T 900	17 900 302	50 pcs	T 900	17 900 302	50 pcs		Grey ●	T 900	17 900 302	50 pcs
	Grey ●	T 927	17 927 302	50 pcs	T 927	17 927 302	50 pcs		Grey ●	T 927	17 927 302	50 pcs
Marker							Marker					
		DK / Z6			DK / Z6				DK / Z6			

NOTE! After placement on the rail, the terminal block must be secured by tightening the screw in its body. Path of the current made of electrotechnical copper and galvanised.

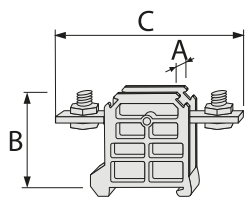

	ZSG1-95.0	ZSG1-120.0	ZSG1-240.0
	95 mm²	120 mm²	240 mm²
Colour Cat. No.			
Grey ●	12 902 312 ●	12 903 312 ●	12 904 312 ●
Blue ●	12 902 313 ●	12 903 313 ●	12 904 313 ●
Yellow ●	12 902 314 ●	12 903 314 ●	12 904 314 ●
Standard	PN-EN 60998-1	PN-EN 60998-1	PN-EN 60998-1
Certificate / declaration	CE	CE	CE
Rated cross-section	95	120	240
Solid wire	10 ... 95 mm ² (with a cable lug)	35 ... 120 mm ² (with a cable lug)	10 ... 240 mm ² (with a cable lug)
Stranded wire	10 ... 95 mm ² (with a cable lug)	35 ... 120 mm ² (with a cable lug)	10 ... 240 mm ² (with a cable lug)
Current data			
Rated voltage (max. impulse)	800 V / 8 kV	800 V / 8 kV	800 V / 8 kV
Rated current	232 A	269 A	415 A
External dimensions			
A / B / C [mm]	41 / 56 / 85	41 / 61 / 86	41 / 66 / 104
Set screw – bolt	M10	M10	M12
Tightening torque	25 ... 30 Nm	25 ... 30 Nm	25 ... 30 Nm
Stripped wire length	29 mm	34 mm	34 mm
Mounting	on TS 35 rail + screw	on TS 35 rail + screw	on TS 35 rail + screw
Weight	221,9 g	222,9 g	365,5 g
Collective packaging			

Optional equipment	Designation	Cat. No.	Col. pack.	Designation	Cat. No.	Col. pack.	Designation	Cat. No.	Col. pack.
Spacer									
Grey ●	T 924	17 924 302	50 pcs	T 924	17 924 302	25 pcs	T 924	17 924 302	25 pcs
End bracket									
Grey ●	T 910	17 910 312	50 pcs	T 910	17 910 312	50 pcs	T 910	17 910 312	50 pcs
Grey ●	T 940	17 940 312	50 pcs	T 940	17 940 312	50 pcs	T 940	17 940 312	50 pcs
Cover	Additional equipment			Additional equipment			Additional equipment		
Yellow ●	Cover ZP 200 (Item No. 89 926 004) 5 pcs			Cover ZP 200 (Item No. 89 926 004) 5 pcs			Cover ZP 200 (Item No. 89 926 004) 5 pcs		
Rail marker									
Grey ●	T 900	17 900 302	50 pcs	T 900	17 900 302	50 pcs	T 900	17 900 302	50 pcs
Grey ●	T 927	17 927 302	50 pcs	T 927	17 927 302	50 pcs	T 927	17 927 302	50 pcs
Marker									
	DK / Z6			DK / Z6			DK / Z6		

NOTE! After placement on the rail, the terminal block must be secured by tightening the screw in its body. Path of the current made of electrotechnical copper and galvanised.

2.1.3

RAIL-MOUNTED SCREW TERMINAL BLOCKS

For special applications

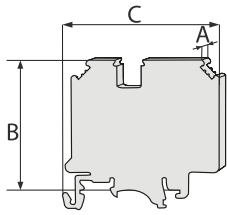

	ZUW3-2.5	ZUW2-4.0
	3x2,5 mm²	2x4 mm²
Colour Cat. No.		
Grey	13 204 312	13 304 312
Standard	PN-EN 60998-1	PN-EN 60998-1
Certificate / declaration	CE	CE
Rated cross-section	2,5	4
Solid wire	0,5 ... 4 mm ²	0,5 ... 6 mm ²
Stranded wire	0,5 ... 2,5 mm ²	0,5 ... 4 mm ²
Current data		
Rated voltage	400 V	400 V
Rated current	24 A	32 A
External dimensions		
A / B / C [mm]	7,5 / 61 / 88	6,5 / 75 / 72
Set screw – bolt	M2,5	M3
Tightening torque	0,4 ... 0,6 Nm	0,4 ... 1,0 Nm
Stripped wire length	10 mm	10 mm
Mounting	on TS 35 rail	on TS 35 rail
Weight	25,9 g	22,4 g
Additional information	3-track	2-track
Collective packaging		

Optional equipment	Designation	Cat. No.	Col. pack.	Designation	Cat. No.	Col. pack.
Spacer						
Grey	body in the set with a cover			T 914	17 914 302	25 pcs
End bracket						
Grey	T 910	17 910 312	50 pcs	T 910	17 910 312	50 pcs
Grey	T 940	17 940 312	50 pcs	T 940	17 940 312	50 pcs
Fixed cross-connection						
2-pole	ZW 22W/T17	18 204 020	10 pcs	ZW 32/T12	18 301 020	10 pcs
10-pole	ZW 21W/T17	18 204 100	10 pcs	ZW 31/T12	18 301 100	10 pcs
Rail marker						
Grey	T 900	17 900 302	50 pcs	T 900	17 900 302	50 pcs
Grey	T 927	17 927 302	50 pcs	T 927	17 927 302	50 pcs
Marker						
		DK / Z5			DK / Z6	
		DK / Z6				

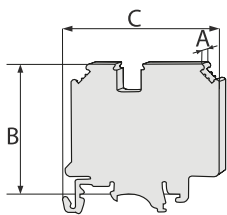

	ZUB1-2.5	ZUB1-2.5D with signal LED
	2,5 mm²	2,5 mm²
Colour Cat. No.		
Grey ●	13 202 312	13 202 972 (12 V) 13 202 982 (230 V) 13 202 992 (24 V)
Standard	PN-EN 60998-1	PN-EN 60998-1
Certificate / declaration	CE	CE
Rated cross-section	2,5	2,5
Solid wire	0,5 ... 4 mm ²	0,5 ... 4 mm ²
Stranded wire	0,5 ... 2,5 mm ²	0,5 ... 2,5 mm ²
Current data		
Rated voltage	400 V	(12 V, 24 V) ∩ / 230 V ~
Rated current	MAX 6,9 A	MAX 6,9 A
External dimensions		
A / B / C [mm]	9 / 55 / 57	9 / 55 / 57
Set screw - bolt	M2,5	M2,5
Tightening torque	0,4 ... 0,6 Nm	0,4 ... 0,6 Nm
Stripped wire length	7 mm	7 mm
Mounting	on TS 32, TS 35 rail	on TS 32, TS 35 rail
Weight	17,4 g	22 g
Additional information	single track / fusible insert 5 x 20 mm	single track / fusible insert 5 x 20 mm
Collective packaging		

Optional equipment	Designation	Cat. No.	Col. pack.	Designation	Cat. No.	Col. pack.
Cover						
Grey ●	body in the set with a cover			body in the set with a cover		
End bracket						
Grey ●	T 910	17 910 312	50 pcs	T 910	17 910 312	50 pcs
Grey ●	T 940	17 940 312	50 pcs	T 940	17 940 312	50 pcs
Rail marker						
Grey ●	T 900	17 900 302	50 pcs	T 900	17 900 302	50 pcs
Grey ●	T 927	17 927 302	50 pcs	T 927	17 927 302	50 pcs
Marker						
		DK / Z6			DK / Z6	

2.1.4

RAIL-MOUNTED SCREW TERMINAL BLOCKS

Protective

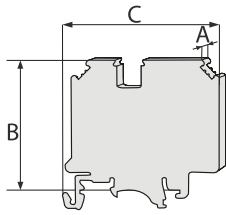





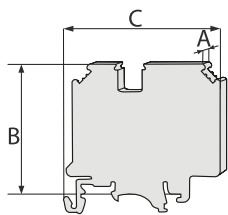

	ZSO1-4.0	ZSO1-6.0
	4 mm²	6 mm²
Colour Cat. No.		
Green-yellow	14 313 319	14 403 319
Standard	PN-EN 60998-1	PN-EN 60998-1
Certificate / declaration	CE	CE
Rated cross-section	4	6
Solid wire	0,5 ... 6 mm ²	0,5 ... 10 mm ²
Stranded wire	0,5 ... 4 mm ²	0,5 ... 6 mm ²
Current data		
Rated voltage (max. impulse)	500 V	500 V
Rated current	32 A	41 A
External dimensions		
A / B / C [mm]	9 / 50 / 58	10 / 47 / 57
Set screw – bolt	M3	M3,5
Tightening torque	0,4 ... 1,0 Nm	0,8 ... 1,6 Nm
Stripped wire length	10 mm	12 mm
Mounting	on TS 35 rail	on TS 35 rail
Weight	27,55 g	30,91 g
Collective packaging		

Optional equipment	Designation	Cat. No.	Col. pack.	Designation	Cat. No.	Col. pack.
End bracket						
Grey	T 910	17 910 312	50 pcs	T 910	17 910 312	50 pcs
Grey	T 940	17 940 312	50 pcs	T 940	17 940 312	50 pcs
Rail marker						
Grey	T 900	17 900 302	50 pcs	T 900	17 900 302	50 pcs
Grey	T 927	17 927 302	50 pcs	T 927	17 927 302	50 pcs
Marker						
		DK / Z5			DK / Z5	

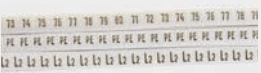

	ZSO1-10.0	ZSO1-16.0	ZSO1-35.0
			
	10 mm²	16 mm²	35 mm²
Colour Cat. No.			
Green-yellow 	14 503 319 	14 603 319 	14 703 319 
Standard	PN-EN 60998-1	PN-EN IEC 60947-7-2	PN-EN IEC 60947-1
Certificate / declaration	CE	CE	CE
Rated cross-section	10	16	35
Solid wire	1,5 ... 10 mm ²	4 ... 16 mm ²	2,5 ... 35 mm ²
Stranded wire	2,5 ... 10 mm ²	2,5 ... 10 mm ²	2,5 ... 25 mm ²
Current data			
Rated voltage (max. impulse)	500 V	800 V	750 V
Rated current	57 A	76 A	125 A
External dimensions			
A / B / C [mm]	10 / 45 / 57	12 / 55 / 56	15 / 58 / 52
Set screw - bolt	M4	screw type +/- M5x12	M6
Tightening torque	1,2 ... 2,0 Nm	2,5 ... 5,0 Nm	2,5 ... 5,0 Nm
Stripped wire length	16 mm	14 mm	24 mm
Mounting	on TS 35 rail	on TS 35 rail	on TS 35 rail
Weight	37,40 g	76,14 g	96,98 g
Collective packaging			

Optional equipment	Designation	Cat. No.	Col. pack.	Designation	Cat. No.	Col. pack.	Designation	Cat. No.	Col. pack.
End bracket									
 Grey 	T 910	17 910 312	50 pcs	T 910	17 910 312	50 pcs	T 910	17 910 312	50 pcs
Grey 	T 940	17 940 312	50 pcs	T 940	17 940 312	50 pcs	T 940	17 940 312	50 pcs
Rail marker									
 Grey 	T 900	17 900 302	50 pcs	T 900	17 900 302	50 pcs	T 900	17 900 302	50 pcs
Grey 	T 927	17 927 302	50 pcs	T 927	17 927 302	50 pcs	T 927	17 927 302	50 pcs
Marker									
		DK / Z6			DK / Z6			DK / Z6	

Screw cross-connections

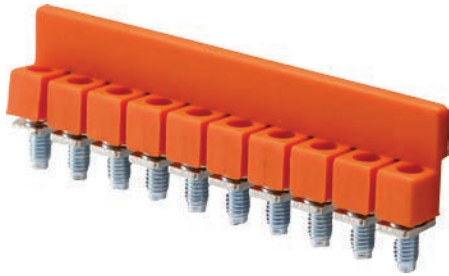

Cross-connections	Term. block	ZSG1-2.5N		ZSG1-4.0N	
		Designation	Cat. No.	Designation	Cat. No.
	2-pole	ZZ2-2.5	18 221 128	ZZ2-4.0	18 321 128
	3-pole	ZZ3-2.5	18 221 138	ZZ3-4.0	18 321 138
	4-pole	ZZ4-2.5	18 221 148	ZZ4-4.0	18 321 148
	10-pole	ZZ10-2.5	18 221 108	ZZ10-4.0	18 321 108

Cross-connections	Term. block	ZSG1-6.0N		ZSG1-10.0N	
		Designation	Cat. No.	Designation	Cat. No.
	2-pole	ZZ2-6.0	18 421 128	ZZ2-10.0	18 521 128
	3-pole	ZZ3-6.0	18 421 138	ZZ3-10.0	18 521 138
	4-pole	ZZ4-6.0	18 421 148	ZZ4-10.0	18 521 148
	10-pole	ZZ10-6.0	18 421 108	ZZ10-10.0	18 521 108

Cross-connections	Term. block	ZSG1-16.0N		ZSG1-35.0N	
		Designation	Cat. No.	Designation	Cat. No.
	2-pole	ZZ2-16.0	18 621 128	ZZ2-35.0	18 721 128
	4-pole	ZZ4-16.0	18 621 148	ZZ4-35.0	18 721 148

Cross-connections	Term. block	ZSG1-70N		ZSG1-120N	
		Designation	Cat. No.	Designation	Cat. No.
	2-pole	ZZ2-70.0	18 951 128	ZZ2-120.0	18 953 128
	3-pole			ZZ3-120.0	18 953 138

Collective packaging:



Plug-in cross-connection for NOWA series



Cross-connections	Term. block	ZSG1-2.5N		ZSG1-4.0N	
		Designation	Cat. No.	Designation	Cat. No.
	2-pole	ZW2-2.5	18 221 328	ZW2-4.0	18 321 328
	10-pole	ZW10-2.5	18 221 308	ZW10-4.0	18 321 308

Cross-connections	Term. block	ZSG1-6.0N	
		Designation	Cat. No.
	2-pole	ZW2-6.0	18 421 328
	10-pole	ZW10-6.0	18 421 308

Collective packaging:



Fixed cross-connection for ZSG 1-16.0, ZSG 1-35.0, ZUW3-2.5 and ZUW2-4.0



Cross-connections	Term. block	ZUW3-2.5		ZUW2-4.0	
		Designation	Cat. No.	Designation	Cat. No.
	2-pole	ZW22W/T17	18 204 020	ZW32/T12	18 301 020
	10-pole	ZW21W/T17	18 204 100	ZW31/T12	18 301 100

Cross-connections	Term. block	ZSG1-16.0		ZSG1-35.0	
		Designation	Cat. No.	Designation	Cat. No.
	2-pole	ZW62/T18	18 601 020	ZW72/T19	18 701 020
	10-pole	ZW61/T18	18 601 100		

Collective packaging:



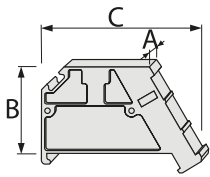

	T910	T940
Colour Cat. No.		
Grey ●	17 910 312	17 940 312
External dimensions		
A / B / C [mm]	8 / 28 / 47	10 / 41 / 54
Weight	8 g	15 g
Mounting	on TS 35 rail	on TS 35 rail
Additional information	end bracket	end bracket, strengthened handle on the rail
Collective packaging		

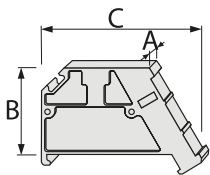

	KU1	KU2	KU3
Colour Cat. No.			
Grey ●	84 019 002	84 033 002	84 044 002
Yellow ●	84 019 004	84 033 004	84 044 004
External dimensions			
A / B / C [mm]	8 / 38 / 44	10 / 48 / 44	10 / 26 / 44
Weight	8 g	13 g	5 g
Mounting	on TS 32, TS 35 rail	on TS 32, TS 35 rail	on TS 32, TS 35 rail
Additional information	holder	holder	holder
Collective packaging			

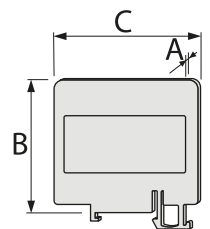

	T914	T921
Colour Cat. No.		
Grey ●	17 914 302	17 921 302
External dimensions		
A / B / C [mm]	1 / 75 / 72	1,5 / 32 / 50
Weight	4,4 g	2,63 g
Mounting		on TS 35 rail
Additional information	spacer for terminal blocks ZUW 2-4.0	spacer for terminal blocks ZSG1-16.0 and ZSG1-35.0
Collective packaging		

2.1.5

ACCESSORIES FOR RAIL-MOUNTED TERMINAL BLOCKS

spacers

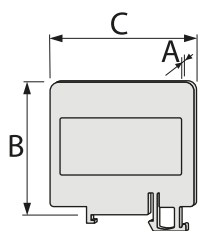



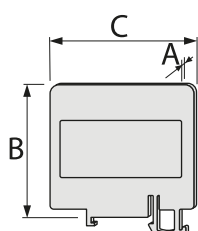

	T922	T923
Colour Cat. No.		
Grey ●	17 922 302	17 923 302
External dimensions		
A / B / C [mm]	1,5 / 72 / 75	1,5 / 32 / 58
Weight	3,2 g	1,5 g
Mounting	on TS 35 rail	
Additional information	spacer for terminal blocks ZSG1-16.0 i ZSG1-35.0	spacer for standard series terminal block ZSG1-35.0
Collective packaging		

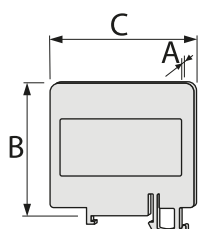

	T924	T925
Colour Cat. No.		
Grey ●	17 924 302	17 925 302
External dimensions		
A / B / C [mm]	5 / 70 / 150	1,5 / 37 / 44
Weight	2 g	2,5 g
Additional information	spacer for ZSG1-70.0 / 95.0 / 120.0 / 240.0	spacer for standard series terminal block ZSG1-16.0
Collective packaging		



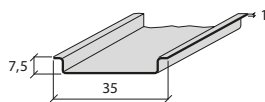

	T928	T929
Colour Cat. No.		
Grey ●	17 928 302	17 929 302
External dimensions		
A / B / C [mm]	1,5 / 23 / 41,5	1,5 / 28 / 46,5
Weight	4 g	4 g
Additional information	spacer for NOWA series ZSG1-2.5N; ZSG1-4.0N	spacer for NOWA series ZSG1-6.0N; ZSG1-10.0N
Collective packaging		

	T900	T927
		
Colour Cat. No.		
Grey ●	17 900 302	17 927 302
External dimensions		
A / B / C [mm]	20 / 40 / 45	10 / 40 / 45
Weight	4 g	2 g
Intended use	markers for TS 35 and TS 32	markers for TS 35
Additional information	with description glass, wide (20 mm)	with description glass, narrow (10 mm)
Collective packaging		

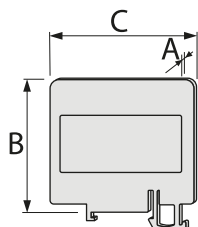

TS 35 rail	
	
Colour Cat. No.	
Metallic	80 035 000
External dimensions	
A / B / C [mm]	1000 / 7,5 / 35
Weight	340 g
Material	steel
Coating	galvanized
Declaration of conformity, standard	IEC 50022; PN-EN 60715
Collective packaging	



ZP200	
	
Colour Cat. No.	
Yellow ●	89 926 004
External dimensions	
A / B / C [mm]	420 / 750 / 200
Weight	8 g
Additional information	Cover for ZSG1-70.0 / 95.0 / 120.0 / 240.0
Collective packaging	

2.1.5

ACCESSORIES FOR RAIL-MOUNTED TERMINAL BLOCKS

markers

Markers for rail-mounted terminal blocks – DK series



	DK / Z6	DK / Z5
L	5,8 ... 6 mm	4,8 ... 5 mm
S	6 mm	6 mm
T	3,2 mm	3,2 mm

Features of DK markers:

- indelible imprint in black colour,
- resistant to the effects of fuel, oils, acids and typical solvents,
- self-extinguishing,
- stable on the conduit or in the socket,
- made of insulating materials,
- protected by a trademark.

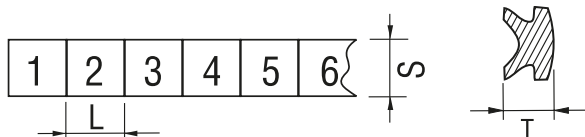

Symbols on DK markers		
Imprints on the marker	0, 1, 2, 3, 4, ... 9); (A, B, C, D, ... Z) (a, b, c, d, ... z); (L1, L2, L3, PE, N) + -	digits, uppercase letters, lowercase letters, symbols, characters
	1, 2, 3, 4, ... 10); (11, 12, 13, ... 20) (21, 22, 23, ... 30); (31,) (391, 392, ... 400); (10, 20, 30, ... 100) etc.	for DK strips 10 markers each

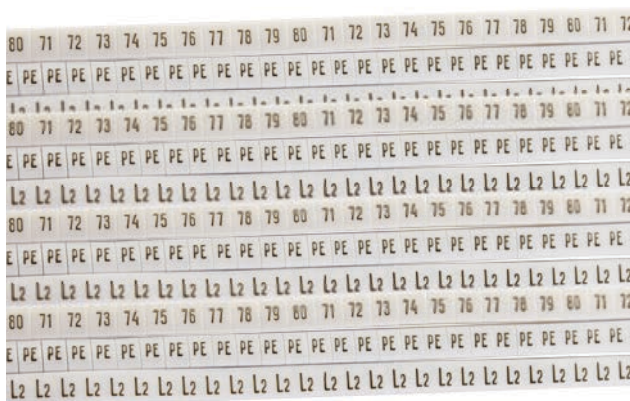

Cat. No.	Designation	Description	Colours	Intended use
89 292 006	DK1/Z6"B/ imprint"	Marker DK 1, Z6 "without imprint"	white	Own designation
89 334 006	DK1/Z5B/imprint	Marker DK 1, Z5 without imprint	white	
89 273 006	DK1/Z5"0"	Marker DK 1, Z5 "0"	white	digit
89 282 006	DK1/Z5"1"	Marker DK 1, Z5 "1"	white	
89 283 006	DK1/Z5"2"	Marker DK 1, Z5 "2"	white	
89 284 006	DK1/Z5"3"	Marker DK 1, Z5 "3"	white	
89 285 006	DK1/Z5"4"	Marker DK 1, Z5 "4"	white	
89 286 006	DK1/Z5"5"	Marker DK 1, Z5 "5"	white	
89 287 006	DK1/Z5"6"	Marker DK 1, Z5 "6"	white	
89 288 006	DK1/Z5"7"	Marker DK 1, Z5 "7"	white	
89 289 006	DK1/Z5"8"	Marker DK 1, Z5 "8"	white	
89 290 006	DK1/Z5"9"	Marker DK 1, Z5 "9"	white	
89 201 006	DK1/Z6"1-10"	Marker DK 1, Z6 "1-10"	white	
89 202 006	DK2/Z6"11-20"	Marker DK 2, Z6 "11-20"	white	
89 203 006	DK2/Z6"21-30"	Marker DK 2, Z6 "21-30"	white	
89 204 006	DK2/Z6"31-40"	Marker DK 2, Z6 "31-40"	white	
89 205 006	DK2/Z6"41-50"	Marker DK 2, Z6 "41-50"	white	
89 206 006	DK2/Z6"51-60"	Marker DK 2, Z6 "51-60"	white	
89 207 006	DK2/Z6"61-70"	Marker DK 2, Z6 "61-70"	white	
89 208 006	DK2/Z6"71-80"	Marker DK 2, Z6 "71-80"	white	
89 209 006	DK2/Z6"81-90"	Marker DK 2, Z6 "81-90"	white	
89 210 006	DK2/Z6"91-100"	Marker DK 2, Z6 "91-100"	white	
89 211 006	DK3/Z6"101-110"	Marker DK 3, Z6 "101-110"	white	
89 212 006	DK3/Z6"111-120"	Marker DK 3, Z6 "111-120"	white	
89 213 006	DK3/Z6"121-130"	Marker DK 3, Z6 "121-130"	white	
89 214 006	DK3/Z6"131-140"	Marker DK 3, Z6 "131-140"	white	
89 215 006	DK3/Z6"141-150"	Marker DK 3, Z6 "141-150"	white	
89 216 006	DK3/Z6"151-160"	Marker DK 3, Z6 "151-160"	white	
89 217 006	DK3/Z6"161-170"	Marker DK 3, Z6 "161-170"	white	
89 218 006	DK3/Z6"171-180"	Marker DK 3, Z6 "171-180"	white	
89 219 006	DK3/Z6"181-190"	Marker DK 3, Z6 "181-190"	white	
89 220 006	DK3/Z6"191-200"	Marker DK 3, Z6 "191-200"	white	
89 221 006	DK3/Z6"201-210"	Marker DK 3, Z6 "201-210"	white	
89 222 006	DK3/Z6"211-220"	Marker DK 3, Z6 "211-220"	white	
89 223 006	DK3/Z6"221-230"	Marker DK 3, Z6 "221-230"	white	
89 224 006	DK3/Z6"231-240"	Marker DK 3, Z6 "231-240"	white	
89 225 006	DK3/Z6"241-250"	Marker DK 3, Z6 "241-250"	white	
89 226 006	DK3/Z6"251-260"	Marker DK 3, Z6 "251-260"	white	
89 227 006	DK3/Z6"261-270"	Marker DK 3, Z6 "261-270"	white	
89 228 006	DK3/Z6"271-280"	Marker DK 3, Z6 "271-280"	white	
89 229 006	DK3/Z6"281-290"	Marker DK 3, Z6 "281-290"	white	
89 230 006	DK3/Z6"291-300"	Marker DK 3, Z6 "291-300"	white	
89 231 006	DK3/Z6"301-310"	Marker DK 3, Z6 "301-310"	white	
89 232 006	DK3/Z6"311-320"	Marker DK 3, Z6 "311-320"	white	
89 233 006	DK3/Z6"321-330"	Marker DK 3, Z6 "321-330"	white	
89 234 006	DK3/Z6"331-340"	Marker DK 3, Z6 "331-340"	white	
89 235 006	DK3/Z6"341-350"	Marker DK 3, Z6 "341-350"	white	
89 236 006	DK3/Z6"351-360"	Marker DK 3, Z6 "351-360"	white	
89 237 006	DK3/Z6"361-370"	Marker DK 3, Z6 "361-370"	white	
89 238 006	DK3/Z6"371-380"	Marker DK 3, Z6 "371-380"	white	
89 239 006	DK3/Z6"381-390"	Marker DK 3, Z6 "381-390"	white	
89 240 006	DK3/Z6"391-400"	Marker DK 3, Z6 "391-400"	white	
89 278 006	DK1/Z5"1-10"	Marker DK 1, Z5 "1-10"	white	
89 279 006	DK2/Z5"11-20"	Marker DK 2, Z5 "11-20"	white	
89 280 006	DK2/Z5"21-30"	Marker DK 2, Z5 "21-30"	white	
89 281 006	DK2/Z5"31-40"	Marker DK 2, Z5 "31-40"	white	
89 297 006	DK2/Z5"41-50"	Marker DK 2, Z5 "41-50"	white	
89 298 006	DK2/Z5"51-60"	Marker DK 2, Z5 "51-60"	white	
89 299 006	DK2/Z5"61-70"	Marker DK 2, Z5 "61-70"	white	
89 300 006	DK2/Z5"71-80"	Marker DK 2, Z5 "71-80"	white	
89 301 006	DK2/Z5"81-90"	Marker DK 2, Z5 "81-90"	white	
89 302 006	DK2/Z5"91-100"	Marker DK 2, Z5 "91-100"	white	
89 275 006	DK2/Z5"L1"	Marker DK 2, Z5 "L1"	white	conductors
89 276 006	DK2/Z5"L2"	Marker DK 2, Z5 "L2"	white	
89 277 006	DK2/Z5"L3"	Marker DK 2, Z5 "L3"	white	
89 295 006	DK1/Z5"L"	Marker DK 1, Z5 "L"	white	
89 296 006	DK1/Z5"N"	Marker DK 1, Z5 "N"	white	
89 303 006	DK2/Z5"PE"	Marker DK 2, Z5 "PE"	white	
89 326 006	DK2/Z5"PEN"	Marker DK 2, Z5 "PEN"	white	
89 332 006	DK1/Z5"earth"/DK1/ Z5"earth"	Marker DK 1, Z5 "earth"	white	pole
89 329 006	DK1/Z5"+"	Marker DK 1, Z5 "+"	white	
89 330 006	DK1/Z5"-"	Marker DK 1, Z5 "-"	white	
89 307 006	DK1/Z5"A"	Marker DK 1, Z5 "A"	white	alphabetical
89 310 006	DK1/Z5"B"	Marker DK 1, Z5 "B"	white	
89 313 006	DK1/Z5"C"	Marker DK 1, Z5 "C"	white	
89 327 006	DK1/Z5"D"	Marker DK 1, Z5 "D"	white	
89 328 006	DK1/Z5"E"	Marker DK 1, Z5 "E"	white	
89 304 006	DK1/Z5"F"	Marker DK 1, Z5 "F"	white	
89 305 006	DK1/Z5"G"	Marker DK 1, Z5 "G"	white	
89 306 006	DK1/Z5"H"	Marker DK 1, Z5 "H"	white	
89 341 006	DK1/Z5"I"	Marker DK 1, Z5 "I"	white	
89 308 006	DK1/Z5"J"	Marker DK 1, Z5 "J"	white	
89 309 006	DK1/Z5"K"	Marker DK 1, Z5 "K"	white	
89 295 006	DK1/Z5"L"	Marker DK 1, Z5 "L"	white	
89 311 006	DK1/Z5"l"	Marker DK 1, Z5 "l"	white	
89 312 006	DK1/Z5"M"	Marker DK 1, Z5 "M"	white	
89 296 006	DK1/Z5"N"	Marker DK 1, Z5 "N"	white	
89 314 006	DK1/Z5"O"	Marker DK 1, Z5 "O"	white	
89 315 006	DK1/Z5"P"	Marker DK 1, Z5 "P"	white	
89 316 006	DK1/Z5"Q"	Marker DK 1, Z5 "Q"	white	
89 317 006	DK1/Z5"R"	Marker DK 1, Z5 "R"	white	
89 318 006	DK1/Z5"S"	Marker DK 1, Z5 "S"	white	
89 319 006	DK1/Z5"T"	Marker DK 1, Z5 "T"	white	
89 320 006	DK1/Z5"U"	Marker DK 1, Z5 "U"	white	
89 321 006	DK1/Z5"V"	Marker DK 1, Z5 "V"	white	
89 322 006	DK1/Z5"W"	Marker DK 1, Z5 "W"	white	
89 323 006	DK1/Z5"X"	Marker DK 1, Z5 "X"	white	
89 324 006	DK1/Z5"Y"	Marker DK 1, Z5 "Y"	white	
89 325 006	DK1/Z5"Z"	Marker DK 1, Z5 "Z"	white	

SIMBLOCK®

RAIL-MOUNTED SCREW TERMINAL BLOCKS STB



product video



marking socket on both side of the terminal block

contact protection that prevents accidental connection of wires

hex key socket for the implementation of high torque



fine thread that allows to increase the clamping force

specially profiled tip of the screws that prevents the damage to the wires



unique shape for better heat dissipation

additional measuring connector for: STB 95 mm², STB 185 mm², STB 300 mm²

internally profiled core intended for aluminium and copper wires

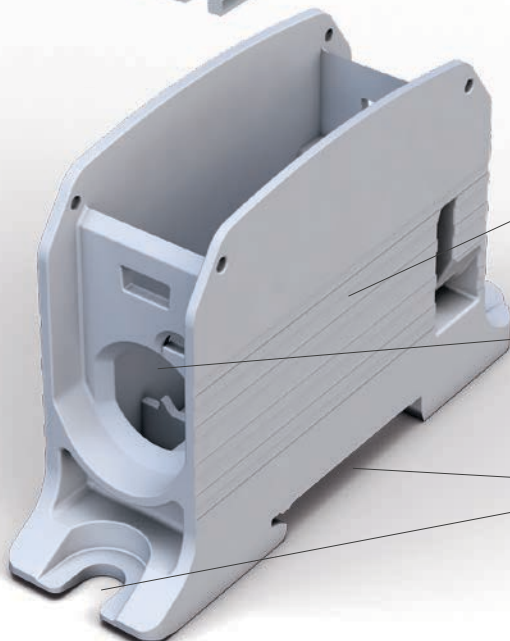

corrugation designed to facilitate heat dissipation

opening for Al/Cu wire up to 300 mm²

simple installation with the use of an open mounting bracket on a mounting plate or on a TS 35 rail

2.1.6

UNIVERSAL SCREW CONNECTORS Al/Cu - STB SERIES

for connection of Al/Cu, Cu/Cu, Al/Al conductors, single-pole, 2 holes



SIMBLOCK®

Al / Cu

Compliance with standards:

- IEC 60947-7-1
- IEC 61238-1
- IEC ITS 60947-7-5

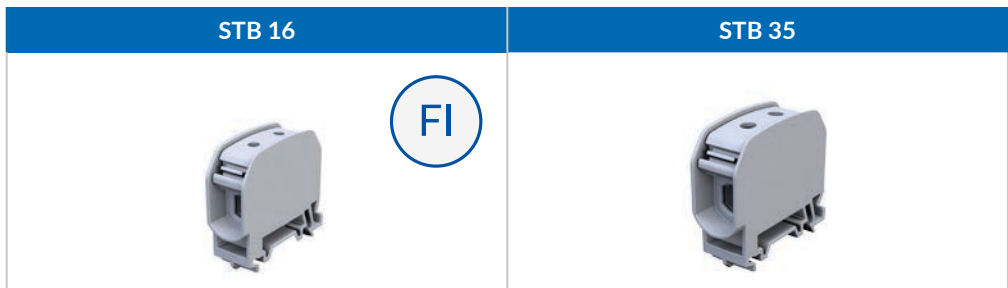

	16 mm ²	35 mm ²
Colour Cat. No.		
Grey ○	81 000 002	81 011 002
Blue ●	81 000 003	81 011 003
Green ●	81 000 005	81 011 005
Brown ●	81 000 015	81 011 015
Black ●	81 000 007	81 011 007
Current data		
Standard	IEC	IEC
Rated voltage	1000 V AC 1000 V DC	1000 V AC 1000 V DC
Rated current	76 A (Cu) 62 A (Al)	125 A (Cu) 90 A (Al)
Rated cross-section		
Input (wire)	2 x (1,5 - 16) mm ²	2 x (4 - 35) mm ²
Input (wire with sleeve)	2 x (1 - 10) mm ²	2 x (2,5 - 25) mm ²
Measuring connector (wire)	-	-
Measuring connector (wire with sleeve)	-	-
Number of poles	1	1
Mounting	on TS 35 rail	on TS 35 rail
External dimensions		
W / H / H1 / L [mm]	15,7 / 43,5 / 37,9 / 47,8	17,2 / 45,5 / 39,9 / 49,6
Weight	23 g	
Additional information		the connector has an additional space for the measurement connector
Collective packaging*		

*These products are also sold in pieces.

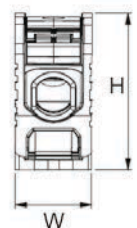
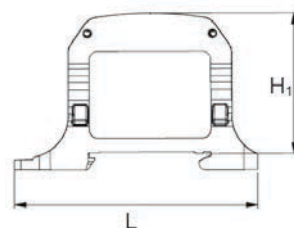
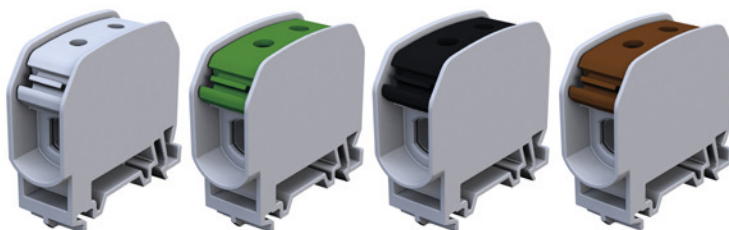

UNIVERSAL SCREW CONNECTORS Al/Cu – STB SERIES

for connection of Al/Cu, Cu/Cu, Al/Al conductors, single-pole, internally compact, 4 holes

2.1.6



SIMBLOCK®

Al / Cu

Compliance with standards:

- IEC 60947-7-1
- IEC 61238-1
- UL-1059
- CSA C22.2 No. 158-10

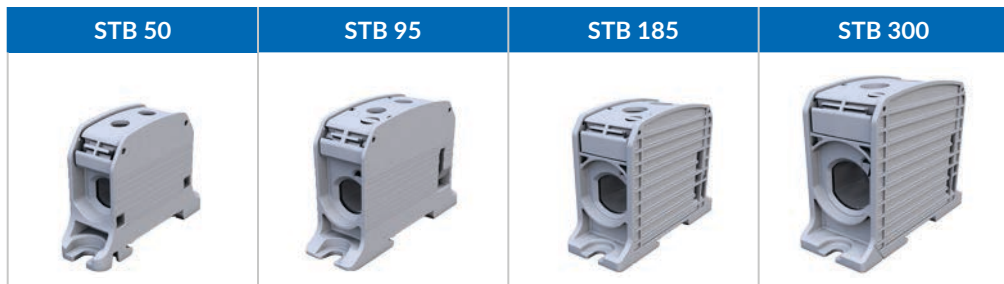

	50 mm ²		95 mm ²		185 mm ²		300 mm ²	
Colour Cat. No.								
Grey ●	81 001 002		81 101 002		81 201 002		81 301 002	
Blue ●	81 001 003		81 101 003		81 201 003		81 301 003	
Green ●	81 001 005		81 101 005		81 201 005		81 301 005	
Brown ●	81 001 015		81 101 015		81 201 015		81 301 015	
Black ●	81 001 007		81 101 007		81 201 007		81 301 007	
Current data								
Standard	IEC	US	IEC	US	IEC	US	IEC	US
Rated voltage	1000 V AC 1000 V DC	1000 V AC	1000 V AC 1000 V DC	1000 V AC	1000 V AC 1000 V DC	1000 V AC	1000 V AC 1000 V DC	1000 V AC
Rated current	150 A (Cu) 150 A (Al)	150 A (Cu) 120 A (Al)	232 A (Cu) 200 A (Al)	200 A (Cu) 155 A (Al)	353 A (Cu) -	310 A (Cu) 250 A (Al)	520 A (Cu) -	420 A (Cu) 340 A (Al)
Rated cross-section								
Input (wire)	2 x (6 - 50) mm ²		2 x (16 - 95) mm ²		2 x (95 - 185) mm ²		2 x (150 - 300) mm ²	
Input (wire with sleeve)	2 x (4 - 35) mm ²		2 x (10 - 70) mm ²		2 x (70 - 150) mm ²		2 x (120 - 240) mm ²	
Measuring connector (wire)	-		1 x (1,5 - 10) mm ²		1 x (1,5 - 10) mm ²		1 x (1,5 - 10) mm ²	
Measuring connector (wire with sleeve)	-		1 x (1,5 - 6) mm ²		1 x (1,5 - 6) mm ²		1 x (1,5 - 6) mm ²	
Number of poles	1		1		1		1	
Mounting	on TS 35 rail, on a mounting plate		on TS 35 rail, on a mounting plate		on TS 35 rail, on a mounting plate		on TS 35 rail, on a mounting plate	
External dimensions								
W / H / H1 / L [mm]	22 / 45 / 40,5 / 70		25,5 / 57 / 52,5 / 93		37,5 / 73,5 / 69 / 105		45 / 83,5 / 79 / 118	
Weight	38 g		96 g		204 g		338 g	
Additional information			the connector has an additional space for the measurement connector		the connector has an additional space for the measurement connector		the connector has an additional space for the measurement connector	
Collective packaging*								

*These products are also sold in pieces.

Optional equipment	Designation	Cat. No.	Col. pack.	Designation	Cat. No.	Col. pack.	Designation	Cat. No.	Col. pack.	Designation	Cat. No.	Col. pack.	
Dust cover													
	Grey ●	OSTB 50	81 901 002	1	OSTB 95	81 902 002	1	OSTB 185	81 903 002	1	OSTB 300	81 904 002	1
Additional information	access to the measurement connector without removing the OSTB												

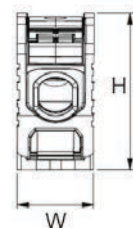
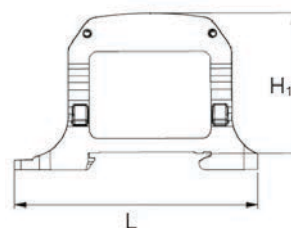

Terminal blocks

2.1.6

UNIVERSAL SCREW CONNECTORS Al/Cu - STB SERIES

for connection of Al/Cu, Cu/Cu, Al/Al conductors, single-pole, 4 holes



SIMBLOCK®

Al / Cu

Compliance with standards:

- IEC 60947-7-1
- IEC 61238-1
- UL-1059
- CSA C22.2 No. 158-10



	STB 50-2		STB 95-2		STB 185-2		STB 300-2	
	50 mm ²		95 mm ²		185 mm ²		300 mm ²	
Colour Cat. No.								
Grey ●	81 002 002		81 102 002		81 202 002		81 302 002	
Blue ●	81 002 003		81 102 003		81 202 003		81 302 003	
Green ●	81 002 005		81 102 005		81 202 005		81 302 005	
Brown ●	81 002 015		81 102 015		81 202 015		81 302 015	
Black ●	81 002 007		81 102 007		81 202 007		81 302 007	
Current data								
Standard	IEC	US	IEC	US	IEC	US	IEC	US
Rated voltage	1000 V AC 1000 V DC	1000 V AC	1000 V AC 1000 V DC	1000 V AC	1000 V AC 1000 V DC	1000 V AC	1000 V AC 1000 V DC	1000 V AC
Rated current	150 A (Cu) 150 A (Al)	150 A (Cu) 120 A (Al)	232 A (Cu) 200 A (Al)	200 A (Cu) 155 A (Al)	353 A (Cu) -	310 A (Cu) 250 A (Al)	520 A (Cu) -	420 A (Cu) 340 A (Al)
Rated cross-section								
Input (wire)	4 x (6 - 50) mm ²		4 x (16 - 95) mm ²		4 x (95 - 185) mm ²		4 x (150 - 300) mm ²	
Input (wire with sleeve)	4 x (4 - 35) mm ²		4 x (10 - 70) mm ²		4 x (70 - 150) mm ²		4 x (120 - 240) mm ²	
Measuring connector (wire)	-		2 x (1,5 - 10) mm ²		2 x (1,5 - 10) mm ²		2 x (1,5 - 10) mm ²	
Measuring connector (wire with sleeve)	-		2 x (1,5 - 6) mm ²		2 x (1,5 - 6) mm ²		2 x (1,5 - 6) mm ²	
Number of poles	1		1		1		1	
Mounting	on TS 35 rail, on a mounting plate		on TS 35 rail, on a mounting plate		on TS 35 rail, on a mounting plate		on TS 35 rail, on a mounting plate	
External dimensions								
W / H / H1 / L [mm]	35,6 / 45 / 40,5 / 70		47 / 57 / 52,5 / 93		67,6 / 73,5 / 69 / 105		82,6 / 83,5 / 79 / 118	
Weight	66 g		178 g		412 g		628 g	
Additional information			the connector has an additional space for the measurement connector		the connector has an additional space for the measurement connector		the connector has an additional space for the measurement connector	
Collective packaging*								

*These products are also sold in pieces.

Optional equipment	Designation	Cat. No.	Col. pack.	Designation	Cat. No.	Col. pack.	Designation	Cat. No.	Col. pack.	Designation	Cat. No.	Col. pack.	
Dust cover													
	Grey ●	OSTB 50	81 901 002	1	OSTB 95	81 902 002	1	OSTB 185	81 903 002	1	OSTB 300	81 904 002	1
Additional information	access to the measurement connector without removing the OSTB												

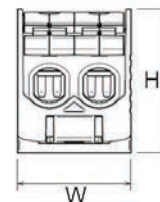
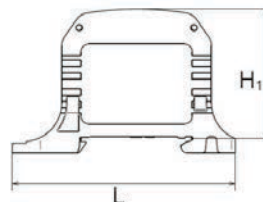



SIMBLOCK®

Al / Cu

Compliance with standards:

- IEC 60947-7-1
- IEC 61238-1
- UL-1059
- CSA C22.2 No. 158-10

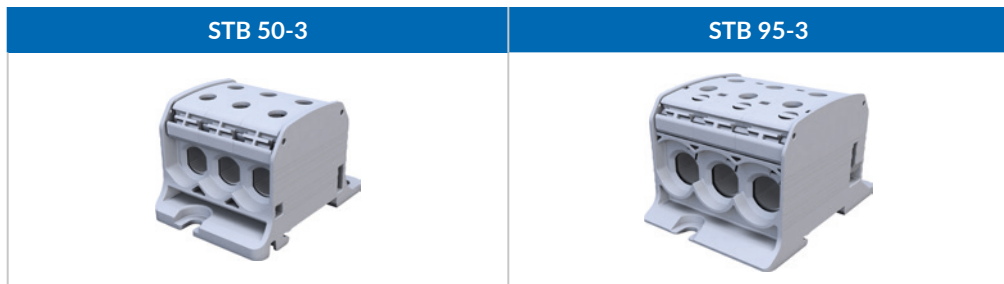

	50 mm ²		95 mm ²	
Colour Cat. No.				
Grey ○	81 003 002		81 103 002	
Blue ●	81 003 003		81 103 003	
Green ●	81 003 005		81 103 005	
Brown ●	81 003 015		81 103 015	
Black ●	81 003 007		81 103 007	
Current data				
Standard	IEC	US	IEC	US
Rated voltage	1000 V AC 1000 V DC	1000 V AC	1000 V AC 1000 V DC	1000 V AC
Rated current	150 A (Cu) 150 A (Al)	150 A (Cu) 120 A (Al)	232 A (Cu) 200 A (Al)	200 A (Cu) 155 A (Al)
Rated cross-section				
Input (wire)	6 x (6 - 50) mm ²		6 x (16 - 95) mm ²	
Input (wire with sleeve)	6 x (4 - 35) mm ²		6 x (10 - 70) mm ²	
Measuring connector (wire)	-		3 x (1,5 - 10) mm ²	
Measuring connector (wire with sleeve)	-		3 x (1,5 - 6) mm ²	
Number of poles	1		1	
Mounting	on TS 35 rail, on a mounting plate		on TS 35 rail, on a mounting plate	
External dimensions				
W / H / H1 / L [mm]	51,2 / 45 / 40,5 / 72		68,6 / 57 / 52,5 / 95	
Weight	112 g		282 g	
Additional information	-		the connector has an additional space for the measurement connector	
Collective packaging				

*These products are also sold in pieces.

Optional equipment	Designation	Cat. No.	Col. pack.	Designation	Cat. No.	Col. pack.
Dust cover						
Grey ○	OSTB 50	81 901 002	1	OSTB 95	81 902 002	1
Additional information	access to the measurement connector without removing the OSTB					

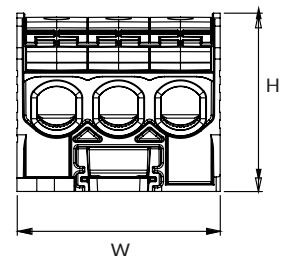
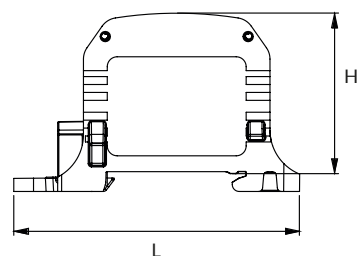

2.1.6

UNIVERSAL SCREW CONNECTORS Al/Cu - STB SERIES

for connection of Al/Cu, Cu/Cu, Al/Al conductors, single-pole (internally compact), 6 holes



SIMBLOCK®

Al / Cu

Compliance with standards:

- IEC 60947-7-1
- IEC 61238-1
- UL-1059
- CSA C22.2 No. 158-10

STB 50-3X



50 mm²

Colour Cat. No.	
Grey ○	81 004 002
Grey ○ / Blue ● / Green ●	81 004 020
Green ● / Grey ○ / Blue ●	81 004 021
Brown ● / Black ● / Grey ○	81 004 022
Current data	
Standard	IEC US
Rated voltage	1000 V AC 1000 V DC 1000 V AC
Rated current	150 A (Cu) 150 A (Al) 150 A (Cu) 120 A (Al)
Rated cross-section	
Input (wire)	2 x (6 - 50) mm ² (per pole)
Input (wire with sleeve)	2 x (4 - 35) mm ² (per pole)
Measuring connector (wire)	-
Measuring connector (wire with sleeve)	-
Number of poles	3
Mounting	on TS 35 rail, on a mounting plate
External dimensions	
W / H / H1 / L [mm]	56,5 / 45 / 40,5 / 70
Weight	104 g
Collective packaging	

Noalox



Antioxidant contact paste for Al/Al and Al/Cu connectors

Colour Cat. No.	
	88 999 006
Rated voltage	600V
Temperature range	-40 °C ... +150 °C
Weight	270 g
Additional information	It is designed to coat the surface of conductors and terminals. The product improves contact between the conductors and the terminal surface, protects it from oxidation and enhances the conductive properties at the point of contact between the conductor and the terminal. It ensures the proper functioning of the connection of aluminium, copper and steel components.
Collective packaging	

Optional equipment	Designation	Cat. No.	Col. pack.
	Dust cover		
	Grey ○	OSTB 50	81 901 002 1

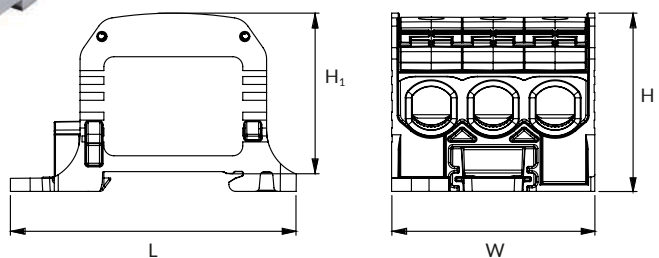

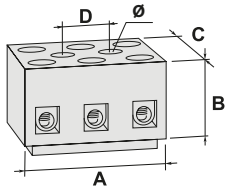

	CPO 1-2.5	CPO 2-2.5	CPO 2-2.5A
	2.5 mm²	2x2.5 mm²	2x2.5 mm²
Colour Cat. No.	White ○	White ○	White ○
Standard	80 015 516	80 016 516	80 017 516
Certificate / declaration	EN 60998-2-1; PN EN 60998-1	EN 60998-2-1; PN EN 60998-1	EN 60998-2-1; PN EN 60998-1
Body	CE	CE	CE
Number of poles	glossy or glazed porcelain	glossy or glazed porcelain	glossy or glazed porcelain
Rated cross-section	1	2	2
Solid wire	4 mm ²	4 mm ²	4 mm ²
Current data			
Rated voltage	500 V	500 V	500 V
Rated current	32 A (wire)	32 A (wire)	32 A (wire)
Operating temperature	-40 °C ... +350 °C	-40 °C ... +350 °C	-40 °C ... +350 °C
Operating temp. of components	+350 °C (insert), +1000 °C (body)	+350 °C (insert), +1000 °C (body)	+350 °C (insert), +1000 °C (body)
External dimensions			
A / B / C / D / Ø [mm]	10,5 / 18 / 24,5	17,5 / 18 / 24,5	23,5 / 18 / 24,5 / 14,5
Set screw - bolt	M3	M3	M3
Stripped wire length	5 mm	5 mm	5 mm
Mounting to the substrate	-	-	M4 x 16
Weight	11 g	18 g	24 g
Additional information			fixing screw M3 x 16 (PN-M82215)
Collective packaging			

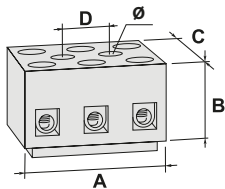





	CPO 3-2.5	CPO 3-2.5A
	3x2.5 mm²	3x2.5 mm²
Colour Cat. No.	White ○	White ○
Standard	80 018 516	80 019 516
Certificate / declaration	EN 60998-2-1; PN EN 60998-1	EN 60998-2-1; PN EN 60998-1
Body	CE	CE
Number of poles	glossy or glazed porcelain	glossy or glazed porcelain
Rated cross-section	2	3
Solid wire	4 mm ²	4 mm ²
Current data		
Rated voltage	500 V	500 V
Rated current	32 A (wire)	32 A (wire)
Operating temperature	-40 °C ... +350 °C	-40 °C ... +350 °C
Operating temp. of components	+350 °C (insert), +1000 °C (body)	+350 °C (insert), +1000 °C (body)
External dimensions		
A / B / C / D / Ø [mm]	25,5 / 18 / 24,5 / 13	36,5 / 18 / 24,5 / 13
Set screw - bolt	M3	M4
Stripped wire length	5 mm	8 mm
Mounting to the substrate	1 x M3	1 x M4
Weight	27 g	37 g
Additional information	fixing screw M4 x 16	fixing screw 2 x M4 x 16
Collective packaging		

2.2

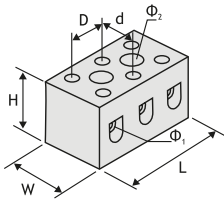

PORCELAIN TERMINAL BLOCKS

CPO porcelain series

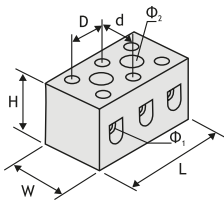

	CPO-5A-1P	CPO-5A-2P
		
	4 mm²	2x4 mm²
Colour Cat. No.		
White ○	80 711 516	80 712 516
Standard	PN-EN 60998-1	PN-EN 60998-1
Certificate / declaration	CE	CE
Body	porcelain	porcelain
Number of poles	1	2
Rated cross-section		
Solid wire	4 mm ²	4 mm ²
Current data		
Rated voltage	450 V	450 V
Rated current	32 A (wire)	32 A (wire)
Operating temperature	+350 °C (insert), +800 °C (body)	+350 °C (insert), +800 °C (body)
External dimensions		
W / L / Ø1 / Ø2 / D / d / H [mm]	18 / 12 / 3,0 / - / - / 8 / 16	18 / 21 / 3,0 / 4,5 / 12 / 8 / 16
Set screw - bolt	M3,5	M3,5
Stripped wire length	5 mm	5 mm
Weight	9 g	14 g
Additional information		with mounting opening
Collective packaging		



	CPO-5A-3P
	
	3x4 mm²
Colour Cat. No.	
White ○	80 713 516
Standard	PN-EN 60998-1
Certificate / declaration	CE
Body	porcelain
Number of poles	3
Rated cross-section	
Solid wire	4 mm ²
Current data	
Rated voltage	450 V
Rated current	32 A (wire)
Operating temperature	+350 °C (insert), +800 °C (body)
External dimensions	
W / L / Ø1 / Ø2 / D / d / H [mm]	18 / 33 / 3,0 / 4,5 / 12 / 8 / 16
Set screw - bolt	M3,5
Stripped wire length	5 mm
Weight	21 g
Additional information	with mounting openings
Collective packaging	

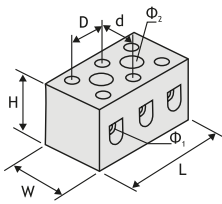

	CPO-10A-2P	CPO-10A-3P
	2x6 mm²	3x6 mm²
Colour Cat. No.	White ○	White ○
Standard	80 013 516 EN 60998-1; EN 60998-2-1	80 014 516 EN 60998-1; EN 60998-2-1
Certificate / declaration	CE	CE
Body	porcelain	porcelain
Number of poles	2	3
Rated cross-section		
Solid wire	6 mm ²	6 mm ²
Current data		
Rated voltage	450 V	450 V
Rated current	57 A (wire)	57 A (wire)
Operating temperature	+350 °C (insert), +800 °C (body)	+350 °C (insert), +800 °C (body)
External dimensions		
W / L / H [mm]	19 / 22 / 18	19 / 36 / 18
Set screw - bolt	M3,5	M3,5
Stripped wire length	5 mm	5 mm
Weight	18,8 g	30 g
Additional information	with mounting opening	with mounting openings
Collective packaging		

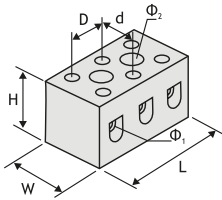

	CPO-15A-1P	CPO-15A-2P	CPO-15A-3P
	10 mm²	2x10 mm²	3x10 mm²
Colour Cat. No.	White ○	White ○	White ○
Standard	80 721 516 EN 60998-1; EN 60998-2-1	80 722 516 EN 60998-1; EN 60998-2-1	80 723 516 EN 60998-1; EN 60998-2-1
Certificate / declaration	CE	CE	CE
Body	porcelain	porcelain	porcelain
Number of poles	1	2	3
Rated cross-section			
Solid wire	10 mm ²	10 mm ²	10 mm ²
Current data			
Rated voltage	450 V	450 V	450 V
Rated current	57 A (wire)	57 A (wire)	57 A (wire)
Operating temperature	+350 °C (insert), +800 °C (body)	+350 °C (insert), +800 °C (body)	+350 °C (insert), +800 °C (body)
External dimensions			
W / L / H [mm]	21 / 13 / 4,2 / - / - / 10 / 20	21 / 24 / 4,2 / 4,8 / 14 / 10 / 20	21 / 36 / 4,2 / 4,8 / 13 / 10 / 20
Set screw - bolt	M3,5	M3,5	M3,5
Stripped wire length	5 mm	5 mm	5 mm
Weight	10 g	24 g	34 g
Additional information		with mounting opening	with mounting openings
Collective packaging			

2.2

PORCELAIN TERMINAL BLOCKS

CPO porcelain series

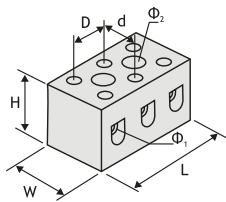

	CPO-30A-1P	CPO-30A-2P
		
	16 mm²	2x16 mm²
Colour Cat. No.		
White ○	80 731 516	80 732 516
Standard	EN 60998-1; EN 60998-2-1	EN 60998-1; EN 60998-2-1
Certificate / declaration	CE	CE
Body	porcelain	porcelain
Number of poles	1	2
Rated cross-section		
Solid wire	16 mm ²	16 mm ²
Current data		
Rated voltage	450 V	450 V
Rated current	76 A (wire)	76 A (wire)
Operating temperature	+350 °C (insert), +800 °C (body)	
External dimensions		
W / L / ø1 / ø2 / D / d / H [mm]	27 / 15 / 5,9 / - / - / 12 / 22	27 / 31 / 5,9 / 5,0 / 17 / 12 / 22
Set screw - bolt	M3,5	M3,5
Stripped wire length	6 mm	6 mm
Weight	21 g	41 g
Additional information		with mounting opening
Collective packaging		

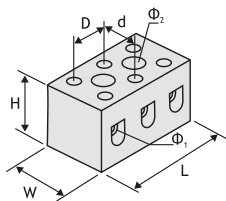

	CPO-30A-3P	
		
	3x16 mm²	
Colour Cat. No.		
White ○	80 733 516	
Standard	EN 60998-1; EN 60998-2-1	
Certificate / declaration	CE	
Body	porcelain	
Number of poles	3	
Rated cross-section		
Solid wire	16 mm ²	
Current data		
Rated voltage	450 V	
Rated current	76 A (wire)	
Operating temperature	+350 °C (insert), +800 °C (body)	
External dimensions		
W / L / ø1 / ø2 / D / d / H [mm]	27 / 48 / 5,9 / 5,0 / 17 / 12 / 22 mm	
Set screw - bolt	M4	
Stripped wire length	8 mm	
Weight	66 g	
Additional information	with mounting opening	
Collective packaging		



WIRE CONNECTORS

3.1

WIRE CONNECTORS

Ideal wire connector for cables and wires (with levers) – SCL series

IDEALNA®
SZYBKOZŁĄCZKA



NEW!

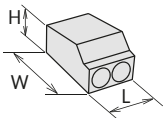

Compliance with standards:

- IEC 60988-1
- IEC 60988-2-2
- *UL 486C

	SCL2	SCL3	SCL5
	with lever	with lever	with lever
Cat. No.	88 000 303S	88 000 313S	88 000 323S
Colours	transparent / blue	transparent / blue	transparent / blue
Rated cross-section			
Solid wire	0,2 ... 4 mm ²	0,2 ... 4 mm ²	0,2 ... 4 mm ²
Stranded wire	0,14 ... 4 mm ²	0,14 ... 4 mm ²	0,14 ... 4 mm ²
Current data			
Rated voltage	450 V / 600 V*	450 V / 600 V*	450 V / 600 V*
Rated current	32 A	32 A	32 A
Operating temp.	up to +85 °C / 105 °C*	up to +85 °C / 105 °C*	up to +85 °C / 105 °C*
External dimensions			
W / L / H [mm]	18,6 / 13,3 / 8,8	18,6 / 18,9 / 8,8	18,6 / 30,4 / 8,8
Stripped wire length	11 - 12 mm ²	11 - 12 mm ²	11 - 12 mm ²
Flame rating	UL94 V2	UL94 V2	UL94 V2
Weight [kg]	0,0027	0,00375	0,0059
Material	polycarbonate; polyketone	polycarbonate; polyketone	polycarbonate; polyketone
Collective packaging			

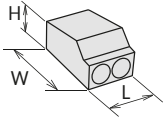

Compliance with standards:

- IEC 60988-1
- IEC 60988-2-2
- *UL 486C

	SCL2 B10	SCL3 B10	SCL COMBO 1
	with lever	with lever	with levers SCL2 / SCL3 / SCL5 - 10 pcs each
Cat. No.	88 001 303	880 001 313	88 000 901
Colours	transparent / blue	transparent / blue	transparent / blue
Rated cross-section			
Solid wire	0,2 ... 4 mm ²	0,2 ... 4 mm ²	0,2 ... 4 mm ²
Stranded wire	0,14 ... 4 mm ²	0,14 ... 4 mm ²	0,14 ... 4 mm ²
Current data			
Rated voltage	450 V / 600 V*	450 V / 600 V*	450 V / 600 V*
Rated current	32 A	32 A	32 A
Operating temp.	up to +85 °C / 105 °C*	up to +85 °C / 105 °C*	up to +85 °C / 105 °C*
External dimensions			
W / L / H [mm]	18,6 / 13,3 / 8,8	18,6 / 18,9 / 8,8	18,6 / 13,3 / 8,8 18,6 / 18,9 / 8,8 18,6 / 30,4 / 8,8
Stripped wire length	11 - 12 mm ²	11 - 12 mm ²	11 - 12 mm ²
Flame rating	UL94 V2	UL94 V2	UL94 V2
Weight [kg]	0,003	0,004	0,126
Material	polycarbonate; polyketone	polycarbonate; polyketone	polycarbonate; polyketone
Collective packaging			



NEW!

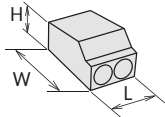

Compliance with standards:

- IEC 60988-1
- IEC 60988-2-2
- *UL 486C, UL 467

	SCP2	SCP3	SCP4
	push-in	push-in	push-in
Cat. No.	88 000 001S	88 000 008S	88 000 004S
Colours	transparent / red	transparent / orange	transparent / yellow
Rated cross-section			
Solid wire	0,75 ... 4 mm ²	0,75 ... 4 mm ²	0,75 ... 4 mm ²
Stranded wire	1,5 ... 2,5 mm ²	1,5 ... 2,5 mm ²	1,5 ... 2,5 mm ²
Current data			
Rated voltage	450 V / 600 V*	450 V / 600 V*	450 V / 600 V*
Rated current	32 A / 20 A*	32 A / 20 A*	32 A / 20 A*
Operating temp.	up to +85 °C / 105 °C*	up to +85 °C / 105 °C*	up to +85 °C / 105 °C*
External dimensions			
W / L / H [mm]	19,81 / 13,21 / 9,65	19,81 / 17,53 / 9,65	19,81 / 20,85 / 9,65
Stripped wire length	13 mm ²	13 mm ²	13 mm ²
Flame rating	UL94 V2	UL94 V2	UL94 V2
Weight [kg]	0,0018	0,00234	0,00268
Material	polycarbonate / tinned copper	polycarbonate / tinned copper	polycarbonate / tinned copper
Collective packaging			

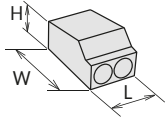

Compliance with standards:

- IEC 60988-1
- IEC 60988-2-2
- *UL 486C, UL 467

	SCP5	SCP6	SCP8
	push-in	push-in	push-in
Cat. No.	88 000 002S	88 000 003S	88 000 007S
Colours	transparent / white	transparent / blue	transparent / grey
Rated cross-section			
Solid wire	0,75 ... 4 mm ²	0,75 ... 4 mm ²	0,75 ... 4 mm ²
Stranded wire	1,5 ... 2,5 mm ²	1,5 ... 2,5 mm ²	1,5 ... 2,5 mm ²
Current data			
Rated voltage	450 V / 600 V*	450 V / 600 V*	450 V / 600 V*
Rated current	24 A / 20 A*	24 A / 20 A*	24 A / 20 A*
Operating temp.	up to +85 °C / 105 °C*	up to +85 °C / 105 °C*	up to +85 °C / 105 °C*
External dimensions			
W / L / H [mm]	18,52 / 23,03 / 9,02	18,52 / 15,32 / 15,42	18,21 / 35,03 / 9,02
Stripped wire length	13 mm ²	13 mm ²	13 mm ²
Flame rating	UL94 V2	UL94 V2	UL94 V2
Weight [kg]	0,0038	0,00458	0,00588
Material	polycarbonate / stainless steel	polycarbonate / stainless steel	polycarbonate / stainless steel
Collective packaging			



3.1

WIRE CONNECTORS

Ideal wire connector for wires – push-in SCP and in-line SCS series

IDEALNA®
SZYBKOZŁĄCZKA



NEW!

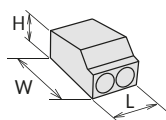

Compliance with standards:

- IEC 60988-1
- IEC 60988-2-2
- *UL 486C, UL 467

	SCP2 B10	SCP3 B10	SCP4 B10
	push-in	push-in	push-in
Cat. No.	88 001 001	88 001 008	88 001 004
Colours	transparent / red	transparent / orange	transparent / yellow
Rated cross-section			
Solid wire	0,75 ... 4 mm ²	0,75 ... 4 mm ²	0,75 ... 4 mm ²
Stranded wire	1,5 ... 2,5 mm ²	1,5 ... 2,5 mm ²	1,5 ... 2,5 mm ²
Current data			
Rated voltage	450 V	450 V	450 V
Rated current	32 A	32 A	32 A
Operating temp.	up to +85 °C	up to +85 °C	up to +85 °C
External dimensions			
W / L / H [mm]	19,81 / 13,21 / 9,65	19,81 / 17,53 / 9,65	19,81 / 20,85 / 9,65
Stripped wire length	13 mm ²	13 mm ²	13 mm ²
Flame rating	UL94 V2	UL94 V2	UL94 V2
Weight [kg]	0,0022	0,0028	
Material	polycarbonate / tinned copper	polycarbonate / tinned copper	polycarbonate / tinned copper
Collective packaging			

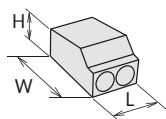

Compliance with standards:

- IEC 60988-1
- IEC 60988-2-2
- *UL 486C, UL 467

	SCS2	SCS2 B10
	in-line	in-line
Cat. No.	88 000 1085	88 001 108
Colours	transparent / orange	transparent / orange
Rated cross-section		
Solid wire	0,5 ... 4 mm ²	0,5 ... 4 mm ²
Stranded wire	1 ... 2,5 mm ²	1 ... 2,5 mm ²
Current data		
Rated voltage	450 V	450 V
Rated current	32 A	32 A
Operating temp.	up to +85 °C	up to +85 °C
External dimensions		
W / L / H [mm]	10,34 / 24,3 / 14,56	10,34 / 24,3 / 14,56
Stripped wire length	13 mm ²	13 mm ²
Flame rating	UL94 V2	UL94 V2
Weight [kg]	0,00146	0,0018
Material	polycarbonate / tinned copper	polycarbonate / tinned copper
Collective packaging		



NEW!



Idealna COMBO 2



- Compliance with standards:
- IEC 60988-1
 - IEC 60988-2-2
 - *UL 486C, UL 467

SCP2 - 30 pcs / SCP3 - 30 pcs / SCP4 - 30 pcs / SCP5 - 30 pcs

Colour Cat. No.	88 000 902
Weight	0,366
Collective packaging	

Idealna COMBO 3



- Compliance with standards:
- IEC 60988-1
 - IEC 60988-2-2
 - *UL 486C, UL 467

SCP2 - 10 pcs / SCP3 - 10 pcs / SCP4 - 10 pcs / SCP6 - 10 pcs
SCL2 - 10 pcs / SCL3 - 10 pcs / SCL5 - 5 pcs / SCS2 - 15 pcs

Colour Cat. No.	88 000 903
Weight	0,336
Collective packaging	

Idealna COMBO 4



- Compliance with standards:
- IEC 60988-1
 - IEC 60988-2-2
 - *UL 486C, UL 467

SCP2 - 30 pcs / SCP3 - 30 pcs / SCP4 - 20 pcs / SCP5 - 15 pcs / SCP6 - 15 pcs /
SCP8 - 10 pcs / SCL2 - 30 pcs / SCL3 - 40 pcs / SCL5 - 20 pcs / SCS2 - 30 pcs

Colour Cat. No.	88 000 904
Weight	0,938
Collective packaging	

3.2

WIRE CONNECTORS MINI series

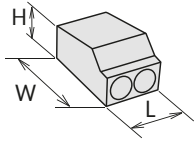

	PC212S	PC213S
	2x2,5 mm²	3x2,5 mm²
Colour Cat. No.		
Transparent <input type="radio"/>	89 240 000	89 241 000
Standard		
Certificate / declaration	CE	CE
Rated cross-section		
Solid wire	0,2 ... 2,5 mm ²	0,2 ... 2,5 mm ²
No. of tracks	2	3
Current data		
Rated voltage	450 V	450 V
Rated current	24 A	24 A
Operating temp.	up to +85 °C	up to +85 °C
External dimensions		
A / B / C [mm]	10 / 17,3 / 6,16	14 / 17,3 / 6,16
Stripped wire length	11 mm	11 mm
Weight	0,76 g	1 g
Material	polycarbonate + stainless steel + tinned copper	polycarbonate + stainless steel + tinned copper
Collective packaging		

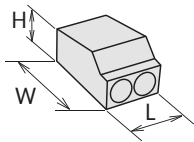

	PC214S	PC215S	PC218S
	4x2,5 mm²	5x2,5 mm²	8x2,5 mm²
Colour Cat. No.			
Transparent <input type="radio"/>	89 242 000	89 243 000	89 244 000
Standard			
Certificate / declaration	CE	CE	CE
Rated cross-section			
Solid wire	0,2 ... 2,5 mm ²	0,2 ... 2,5 mm ²	0,2 ... 2,5 mm ²
No. of tracks	4	5	8
Operating parameters			
Rated voltage	450 V	450 V	450 V
Rated current	24 A	24 A	24 A
Operating temp.	up to +85 °C	up to +85 °C	up to +85 °C
External dimensions			
A / B / C [mm]	18 / 17,3 / 6,16	22 / 17,3 / 6,16	18 / 16 / 10,8
Stripped wire length	11 mm	11 mm	11 mm
Weight	1,34 g	1,64 g	2,19 g
Material	polycarbonate + stainless steel + tinned copper	polycarbonate + stainless steel + tinned copper	polycarbonate + stainless steel + tinned copper
Collective packaging			



ZSE-1.0/6.0



Colour Cat. No.	
Yellow	43 814 204
Green	43 814 205
Blue	43 814 203
Red	43 814 201
Black	43 814 207
Standard	EN 60998-2-4
Certificate / declaration	CE
No. of tracks	1
Operating temperature	-25 °C ... +125 °C
Rated cross-section	1 ... 6 mm ²
Current data	
Rated voltage	400 V
Rated current	41 A
External dimensions	
A / B [mm]	19 / 27
Weight	12 g
Number of conductors connected in one clamp	for 1 mm ² - 2 ... 8 conductors for 1,5 mm ² - 2 ... 6 conductors for 2,5 mm ² - 2 ... 5 conductors for 4 mm ² - 2 ... 3 conductors for 6 mm ² - 2 conductors
Intended use	The twist connector allows for the connection of conductors with a wide range of nominal cross-sections. It can connect conductors from 1 mm ² to 6 mm ² . A new feature is the use of a square wire clamp. Such clamp allows the surface of the wires to be threaded, making the connection more durable. The connector is designed for wire conductors, but it can also be used for multi-stranded conductors, whereby the holding force is considerably reduced. The large contact surface and the high clamping force ensure the good quality of this solution for connecting wires.
Additional information	Body material PA 66.
Collective packaging	



Simply insert the stripped wire ends and twist. The clamp will lightly thread the wire surface and twist it into a tight braid.



View of the clamp in the twist connector







3.4





WIRE CONNECTORS

for cables and wires

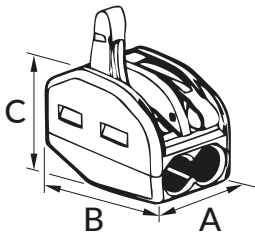

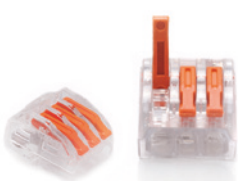
	PC301-CL	PC302-CL
		
	2,5 mm² / 2,5 mm²	2,5 mm² / 2x2,5 mm²
Colour Cat. No.		
Grey ●	89 006 002	_____
White ○	_____	89 007 006
Number of conductors	1	2
Cross-section and type of conductors		
Power supply side	0,75 - 2,5 mm ² , wire	0,75 - 2,5 mm ² , wire
Lighting side	0,5 - 2,5 mm ² , wire or stranded wire	2x0,5 - 2,5 mm ² , wire or stranded wire
Current data		
Rated current	24 A	17,5 A
Rated voltage	450 V	450 V
Operating temp.	-30 °C ... +105 °C	-30 °C ... +105 °C
External dimensions		
A / B / C [mm]	20,8 / 15,8 / 8,1	20,8 / 15,9 / 9,5
Application	EASY LINK connectors are intended for installation of lighting and other electrical works. They enable connection of wires and stranded wires. They are made of self-extinguishing material and compliant with the standard (UL 94V-2). They have a self-locking wire connection system.	
Collective packaging		



	ZU-402	ZU-403	ZU-405
			
	2x4 mm²	3x4 mm²	5x4 mm²
Colour Cat. No.			
Transparent/ orange ●○	85 122 000	85 123 000	85 125 000
Rated cross-section			
Solid wire/Stranded wire	0,2 ... 4 mm ²	0,2 ... 4 mm ²	0,2 ... 4 mm ²
No. of tracks	2	3	5
Rated voltage	450 V	450 V	450 V
Operating temp.	+105 °C	+105 °C	+105 °C
Rated current			
	32 A	32 A	32 A
External dimensions			
A / B / C [mm]	12,2 / 20,8 / 14,5	17,0 / 20,8 / 14,5	26,1 / 20,8 / 14,5
Stripped wire length	10 mm	10 mm	10 mm
Application	Universal connectors for single and multi-stranded wires. With a range of 0,2 mm ² to 4 mm ² , they can be used for all connection conductors: luminaires, blind control installations, door and gate controls, public address installations, etc.		
Collective packaging			



DISTRIBUTION BLOCKS

SIMBLOCK®

SCB BRANCH DISTRIBUTION BLOCKS



product video

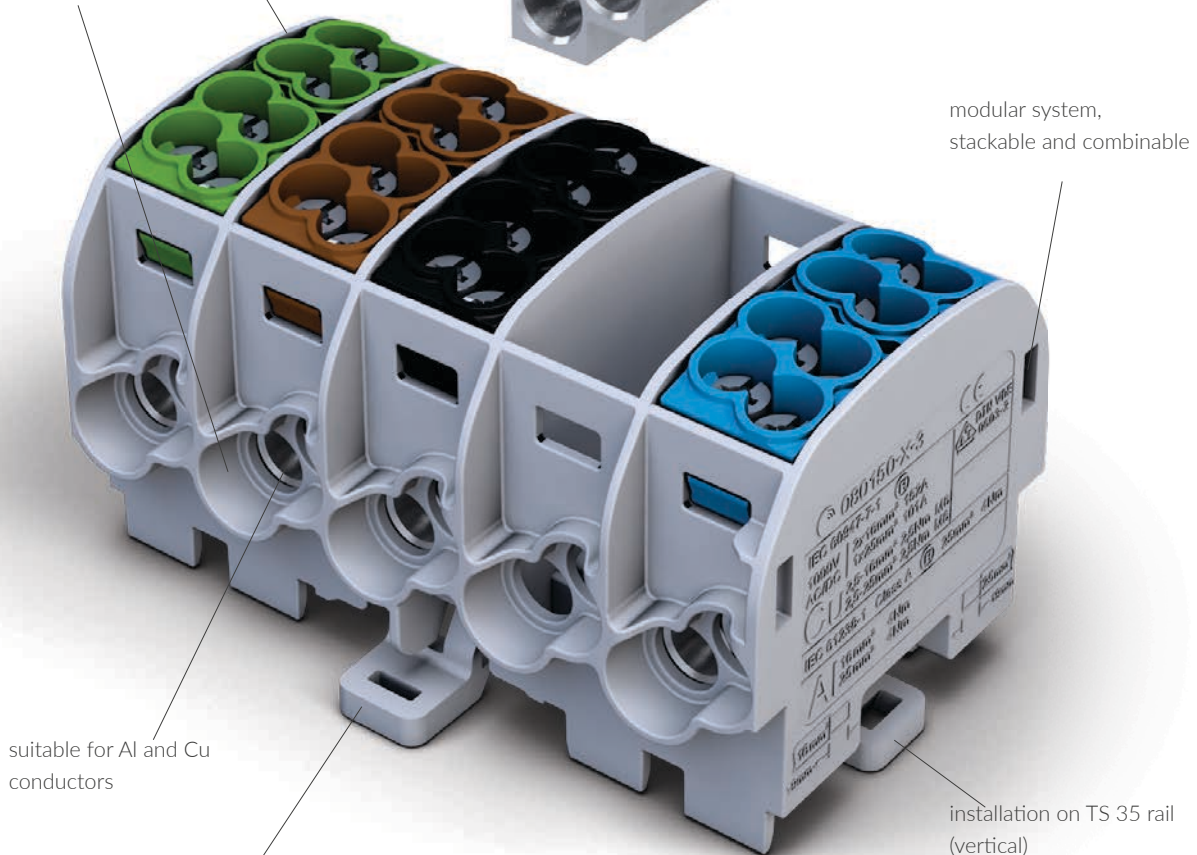
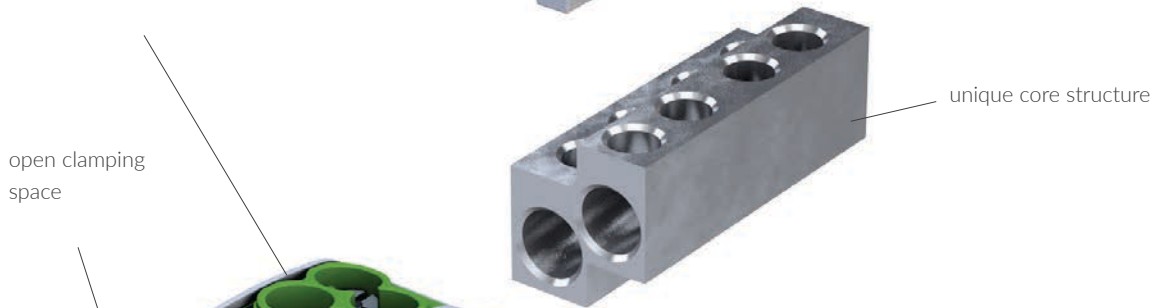



SIMBLOCK®

Al / Cu

Compliance with standards:

- IEC 60947-7-1
- IEC 61238-1
- UL-1059
- CSA C22.2 No. 158-10



	SCB 25	SCB 35	SCB 70
	2x16 mm ² / 2x25 mm ²	2x25 mm ² / 2x35 mm ²	2x70 mm ² / 2x50 mm ²
Colour Cat. No.			
Grey ○	81 501 002	81 502 002	81 508 002
Blue ●	81 501 003	81 502 003	81 508 003
Green ●	81 501 005	81 502 005	81 508 005
Brown ●	81 501 015	81 502 015	81 508 015
Black ●	81 501 007	81 502 007	81 508 007
Current data			
Standard	IEC	IEC	IEC
Rated voltage	1000 V AC 1000 V DC	1000 V AC 1000 V DC	1000 V AC 1000 V DC
Rated current	152 A (Cu) 100 A (Al)	202 A (Cu) 125 A (Al)	300 A (Cu) 300 A (Al)
Rated cross-section			
Input (wire)	2 x (2,5 - 25) mm ²	2 x (4 - 35) mm ²	2 x (10 - 70) mm ²
Input (wire with sleeve)	2 x (1,5 - 16) mm ²	2 x (2,5 - 25) mm ²	2 x (6 - 50) mm ²
Output (wire)	2 x (2,5 - 16) mm ²	2 x (2,5 - 16) mm ²	2 x (6 - 50) mm ²
Output (wire with sleeve)	2 x (1,5 - 10) mm ²	2 x (1,5 - 10) mm ²	2 x (4 - 35) mm ²
Number of poles	1	1	1
Mounting	on TS 35 rail	on TS 35 rail	on TS 35 rail
External dimensions			
W / H / H1 / L [mm]	17,8 / 49,3 / 44,7 / 55,7	29 / 49,3 / 44,7 / 55,4	32,8 / 53,3 / 48,6 / 63
Weight	68 g	92 g	171 g
Additional information	can be combined in sections	can be combined in sections	can be combined in sections
Collective packaging*			

*These products are also sold in pieces.

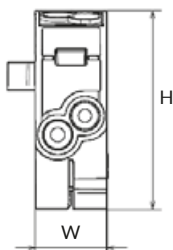
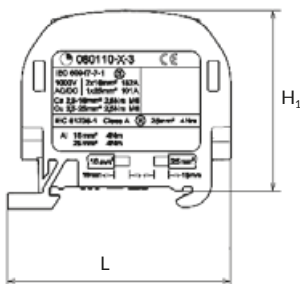

4.1

BRANCH DISTRIBUTION BLOCKS Al/Cu - SCB SERIES

for connection of Al/Cu, Cu/Cu, Al/Al, single pole



NEW!

SIMBLOCK®

Al / Cu

Compliance with standards:

- IEC 60947-7-1
- IEC 61238-1



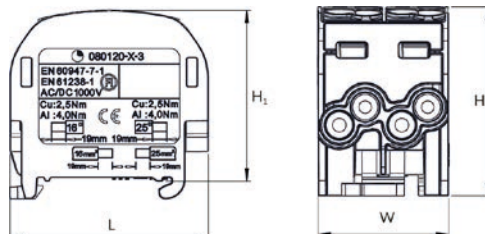

	SCB 25-2	SCB 35-2
	4x16 mm² / 4x25 mm²	4x25 mm² / 4x35 mm²
Colour Cat. No.		
Grey ○	81 505 002	81 506 002
Blue ●	81 505 003	81 504 003
Green ●	81 505 005	81 504 005
Brown ●	81 505 015	81 504 015
Black ●	81 505 007	81 504 007
Current data		
Standard	IEC	IEC
Rated voltage	1000 V AC 1000 V DC	1000 V AC 1000 V DC
Rated current	152 A (Cu) 100 A (Al)	428 A (Cu) 125 A (Al)
Rated cross-section		
Input (wire)	4 x (2,5 - 25) mm ²	4 x (4 - 35) mm ²
Input (wire with sleeve)	4 x (1,5 - 16) mm ²	4 x (2,5 - 25) mm ²
Output (wire)	4 x (2,5 - 16) mm ²	4 x (2,5 - 25) mm ²
Output (wire with sleeve)	4 x (1,5 - 10) mm ²	4 x (1,5 - 16) mm ²
Number of poles	1	1
Mounting	on TS 35 rail	on TS 35 rail
External dimensions		
W / H / H1 / L [mm]	34,2 / 49,3 / 44,7 / 52	43,2 / 49,3 / 44,7 / 55,4
Weight	134 g	180 g
Additional information	can be combined in sections	can be combined in sections and installed vertically or horizontally
Collective packaging*		



SIMBLOCK®

Al / Cu

- Compliance with standards:
- IEC 60947-7-1
 - IEC 61238-1

	SCB 25-5X	SCB 35-5X
		NEW! 
	5x(2x16 mm² / 2x25 mm²)	5x(2x25 mm² / 2x35 mm²)
Colour Cat. No.		
Grey ○	81 500 002	81 507 002
Grey ○ / Blue ● / Green ●	81 500 020	81 507 020
Grey ○ / Blue ● / Green ● Brown ● / Black ●	-	81 507 030
Current data		
Standard	IEC	IEC
Rated voltage	1000 V AC 1000 V DC	1000 V AC 1000 V DC
Rated current	152 A (Cu) 100 A (Al)	202 A (Cu) 125 A (Al)
Rated cross-section		
Input (wire)	5 x (2x (2,5 - 25 mm ²))	5 x (2x (4 - 35 mm ²))
Input (wire with sleeve)	5 x (2x (1,5 - 16 mm ²))	5 x (2x (2,5 - 25 mm ²))
Output (wire)	5 x (2x (2,5 - 16 mm ²))	5 x (2x (2,5 - 25 mm ²))
Output (wire with sleeve)	5 x (2x (1,5 - 10 mm ²))	5 x (2x (1,5 - 16 mm ²))
Number of poles	5	5
Mounting	on TS 35 rail	on TS 35 rail
External dimensions		
W / H / H1 / L [mm]	88,8 / 49,3 / 44,7 / 55,7	110,9 / 49,3 / 44,7 / 55,4
Weight	341 g	453 g
Additional information	can be combined in sections and installed vertically or horizontally	can be combined in sections and installed vertically or horizontally
Collective packaging		

Distribution blocks

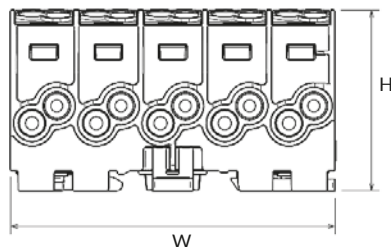
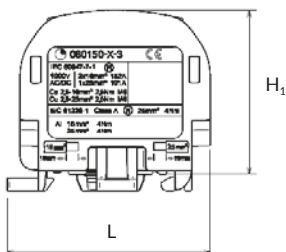

4.1

BRANCH DISTRIBUTION BLOCKS Cu/Cu - SCB SERIES

for connection of Cu/Cu, single pole



SIMBLOCK®

Cu

Compliance with standards:

- IEC 60947-7-1
- IEC 61238-1

	SCB 25-Cu	SCB 35-Cu
	2x16 mm² / 2x25 mm²	2x25 mm² / 2x35 mm²
Colour Cat. No.		
Grey ○	81 503 002	81 504 002
Blue ●	81 503 003	81 504 003
Green ●	81 503 005	81 504 005
Brown ●	81 503 015	81 504 015
Black ●	81 503 007	81 504 007
Current data		
Standard	IEC	IEC
Rated voltage	1000 V AC 1000 V DC	1000 V AC 1000 V DC
Rated current	152 A (Cu)	202 A (Cu)
Rated cross-section		
Input (wire)	2 x (2,5 - 25 mm ²)	2 x (4 - 35 mm ²)
Input (wire with sleeve)	2 x (1,5 - 16 mm ²)	2 x (2,5 - 25 mm ²)
Output (wire)	2 x (2,5 - 16 mm ²)	2 x (2,5 - 25 mm ²)
Output (wire with sleeve)	2 x (1,5 - 10 mm ²)	2 x (1,5 - 16 mm ²)
Number of poles	1	1
Mounting	on TS 35 rail	on TS 35 rail
External dimensions		
W / H / H1 / L [mm]	17,8 / 49,3 / 44,7 / 55,7	29 / 49,3 / 44,7 / 55,4
Weight	68 g	92 g
Additional information	can be combined in sections	can be combined in sections
Collective packaging*		

*These products are also sold in pieces.

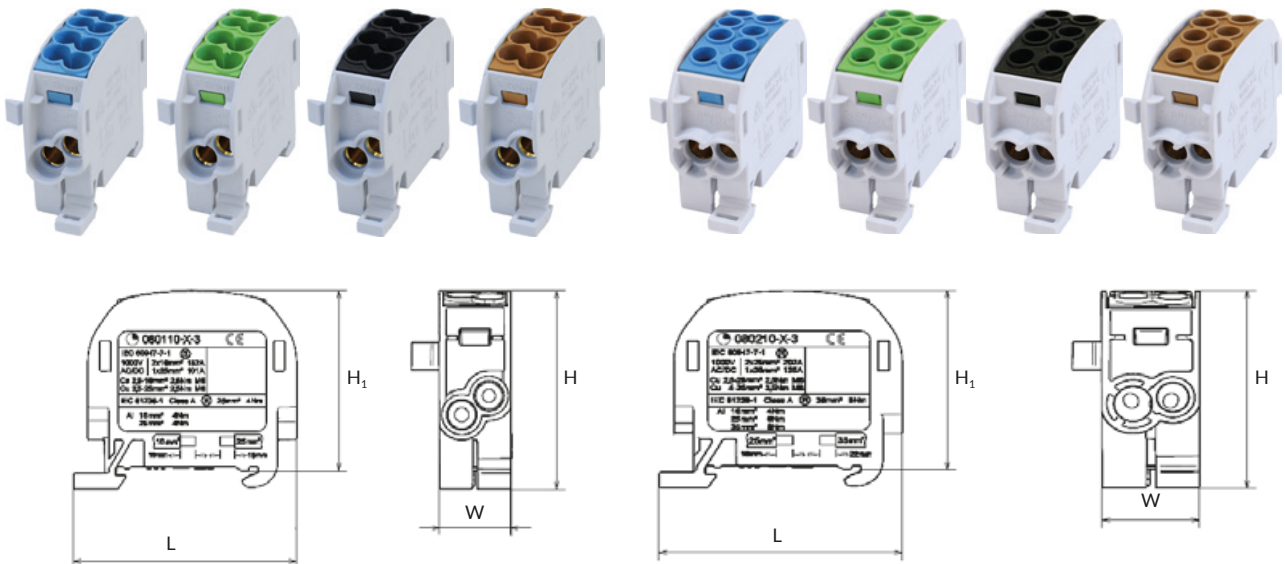

SIMBLOCK®

SDB DISTRIBUTION BLOCKS

incoming circuits: identification
with letters

round
edges

housing to prevent
accidental finger contact
with active parts

hexagon head screws:
transmission
of high torque moments

fine pitch thread:
transmission of
high torque moments

optimized brass body

internally profiled hole
dedicated
to all sleeved cables

hole for a bridge or cable

outgoing circuits:
identification with figures

simple installation
on TS 35 rail

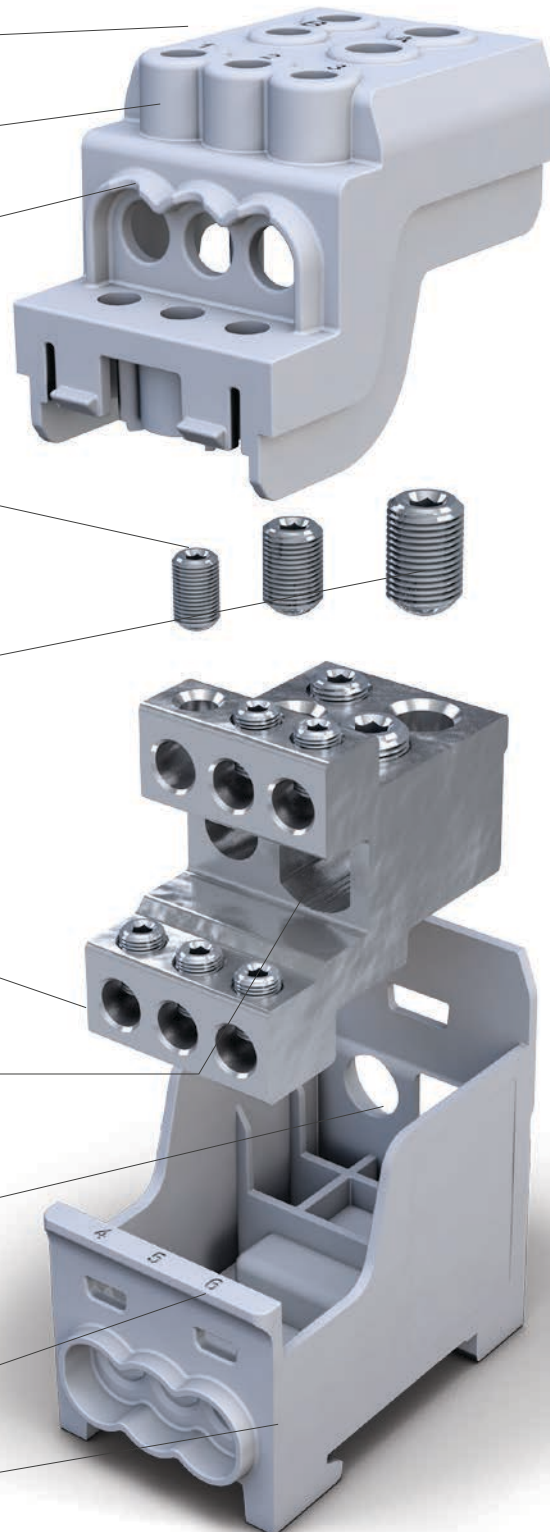



SIMBLOCK®

Al / Cu

Compliance with standards:

- EN 60998-2-1
- EN 60947-7-1
- IEC 61238-1 (Class A)

	SDB 100	SDB 200
	2x25 mm² / 6x10 mm²	1x70 mm² / 1x35 mm² / 6x16 mm²
Colour Cat. No.		
Grey ○	81 601 002	81 602 002
Blue ●	81 601 003	81 602 003
Green ●	81 601 005	81 602 005
Brown ●	81 601 015	81 602 015
Black ●	81 601 007	81 602 007
Current data		
Standard	IEC	IEC
Rated voltage	1000 V AC	1000 V AC 1500 V DC
Rated current	101 A (Cu) 100 A (Al)	192 A (Cu) 170 A (Al)
Rated cross-section		
Input (wire)	2 x (2,5 - 25) mm ²	1 x (10 - 70) mm ²
Input (wire with sleeve)	2 x (1,5 - 16) mm ²	1 x (6 - 50) mm ²
Output (wire)	6 x (1,5 - 10) mm ²	6 x (1,5 - 16) / 1 x (4 - 35) mm ²
Output (wire with sleeve)	6 x (1,5 - 6) mm ²	6 x (1,5 - 10) / 1 x (2,5 - 25) mm ²
Mounting	on TS 35 rail	on TS 35 rail
External dimensions		
W / H / H ₁ / L [mm]	30,2 / 49 / 45,5 / 55,4	38,5 / 63 / 57,5 / 69,75
Weight	101 g	267 g
Collective packaging		

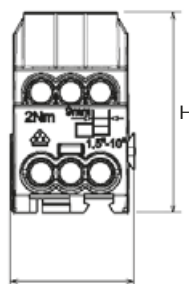
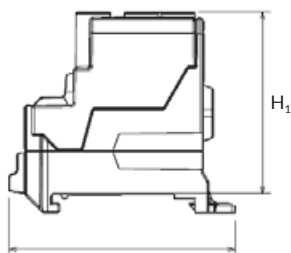

SIMBLOCK®

SUB UNIVERSAL DISTRIBUTION BLOCKS

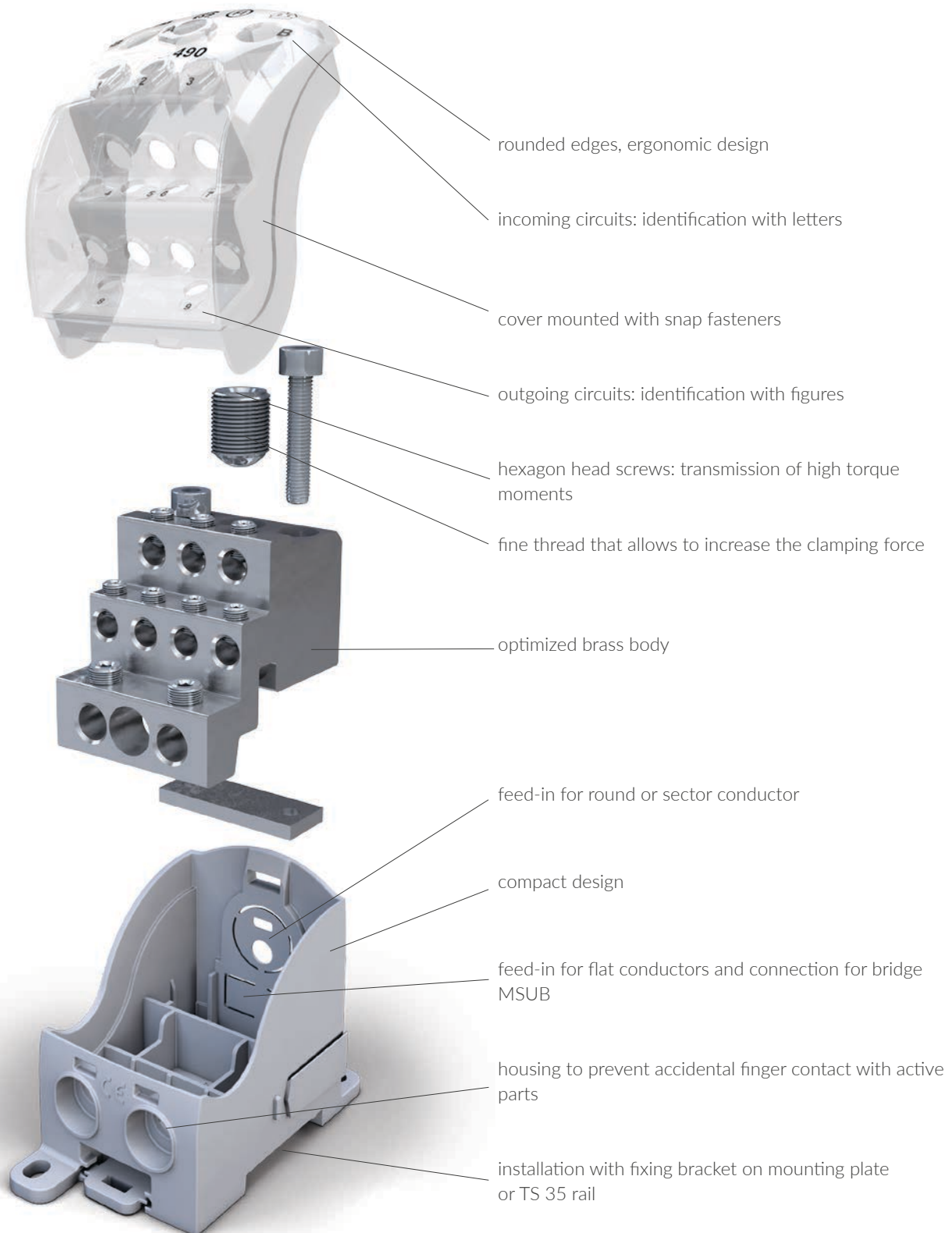

4.3

UNIVERSAL DISTRIBUTION BLOCKS Al/Cu - SERIA SUB

for connection of Al/Cu, Cu/Cu, Al/Al, single pole



SIMBLOCK®

Al / Cu

Compliance with standards:

- IEC 60947-7-1
- UL-1059

	SUB 160		SUB 210		SUB 220		SUB 270	
	25 mm ²		35 mm ²		70 mm ²		95 mm ²	
Colour Cat. No.								
Grey ○	81 653 002		81 654 002		81 650 002		81 655 002	
Blue ●	81 653 003		81 654 003		81 650 003		81 655 003	
Current data								
Standard	IEC	US	IEC	US	IEC	US	IEC	US
Rated voltage	1000 V AC 1000 V DC	600 V AC	1000 V AC 1000 V DC	600 V AC	1000 V AC 1000 V DC	600 V AC	1000 V AC 1000 V DC	600 V AC
Rated current	101 A (Cu) 164 A (Cu)	85 A (Cu) 65 A (Al)	125 A (Cu) 214 A (Cu)	115 A (Cu) 90 A (Al)	192 A (Cu) 215 A (Cu)	160 A (Cu) 135 A (Al)	232 A (Cu) 270 A (Cu)	200 A (Cu) 155 A (Al)
Rated cross-section								
Input (wire)	1 x (2,5 - 25) mm ²		1 x (4 - 35) mm ²		1 x (10 - 70) mm ²		1 x (16 - 95) mm ²	
Input (wire with sleeve)	2 x (1,5 - 16) mm ²		1 x (2,5 - 25) mm ²		1 x (6 - 50) mm ²		1 x (10 - 70) mm ²	
Input (flat wire)	MSUB 2-160; MSUB 3-160		MSUB 2-210; MSUB 3-210		1 x (15,5 x 5) mm ²		-	
Output (wire)	1 x (1,5 - 16) / 2 x (1,5 - 16) / 3 x (1,5 - 10) mm ²		1 x (1,5 - 16) / 2 x (2,5 - 25) / 3 x (1,5 - 16) mm ²		2 x (2,5 - 25) / 3 x (1,5 - 16) mm ²		2 x (4 - 35) / 8 x (2,5 - 25) mm ²	
Output (wire with sleeve)	1 x (1,5 - 10) / 2 x (1,5 - 10) / 3 x (1,5 - 6) mm ²		1 x (1,5 - 10) / 2 x (1,5 - 16) / 3 x (1,5 - 10) mm ²		2 x (1,5 - 16) / 3 x (1,5 - 10) mm ²		2 x (2,5 - 25) / 8 x (1,5 - 16) mm ²	
Mounting	on TS 35 rail, on a mounting plate		on TS 35 rail, on a mounting plate		on TS 35 rail, on a mounting plate		on TS 35 rail, on a mounting plate	
External dimensions								
W / H / H1 / L [mm]	33 / 49 / 44 / 68		37,1 / 53,7 / 48,7 / 70		41 / 52,5 / 45,4 / 74,5		52,5 / 54,5 / 49,5 / 73	
Weight	94 g		136 g		200 g		216 g	
Additional information	possibility to electrically connect two SUB 160 units by using connecting bridge MSUB 2-160 or three by using MSUB 3-160; can be combined in sections		possibility to electrically connect two SUB 210 units by using connecting bridge MSUB 2-210 or three by using MSUB 3-210; can be combined in sections		can be combined in sections		can be combined in sections	
Collective packaging								

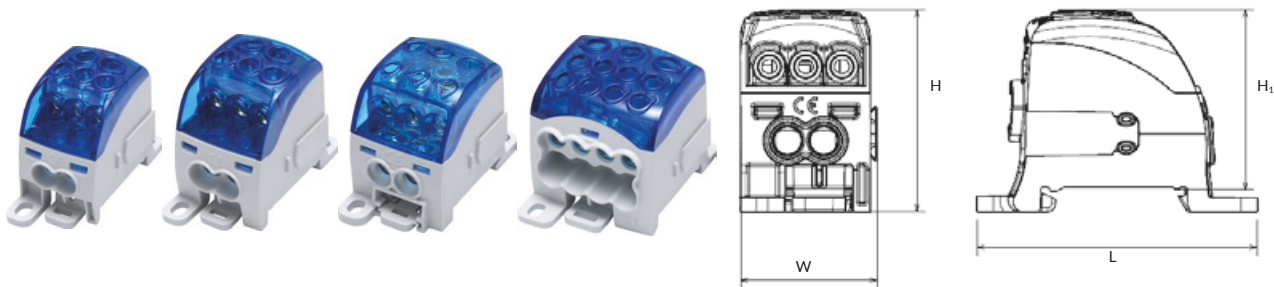

	CONNECTING BRIDGE			
	MSUB 2-160	MSUB 3-160	MSUB 2-210	MSUB 3-210
	16 mm ²	16 mm ²	16 mm ²	16 mm ²
Colour Cat. No.				
Grey ○	81 905 006	81 906 006	81 907 006	81 908 006
Collective packaging				



SIMBLOCK®

Al / Cu

Compliance with standards:

- IEC 60947-7-1
- UL-1059

	SUB 400		SUB 490	
	120 mm ²		185 mm ²	
Colour Cat. No.				
Grey ●	81 651 002		81 652 002	
Blue ●	81 651 003		81 652 003	
Current data				
Standard	IEC	US	IEC	US
Rated voltage	1000 V AC 1500 V DC	600 V AC	1000 V AC 1500 V DC	600 V AC
Rated current	269 A (Cu) 400 A (Cu)	250 A (Cu) 205 A (Al)	353 A (Cu) 490 A (Cu)	310 A (Cu) 250 A (Al)
Rated cross-section				
Input (wire)	1 x (35 - 120) mm ²		1 x (95 - 185) mm ²	
Input (wire with sleeve)	1 x (25 - 95) mm ²		1 x (70 - 150) mm ²	
Input (flat wire)	1 x (24x10) mm ²		1 x (24x10) mm ²	
Output (wire)	2 x (4 - 35) / 3 x (2,5 - 25) / 4 x (1,5 - 16) mm ²		2 x (4 - 35) / 3 x (2,5 - 25) / 4 x (1,5 - 16) mm ²	
Output (wire with sleeve)	2 x (2,5 - 25) / 3 x (1,5 - 16) / 4 x (1,5 - 10) mm ²		2 x (2,5 - 25) / 3 x (1,5 - 16) / 4 x (1,5 - 10) mm ²	
Mounting	on TS 35 rail, on a mounting plate		on TS 35 rail, on a mounting plate	
External dimensions				
W / H / H ₁ / L [mm]	52,7 / 77,7 / 72,5 / 95		52,7 / 77,7 / 72,5 / 95	
Weight	518 g		496 g	
Additional information	can be combined in sections		can be combined in sections	
Collective packaging				

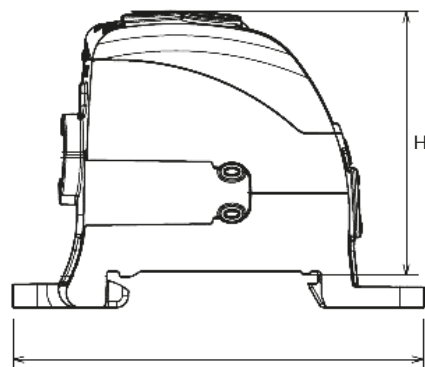
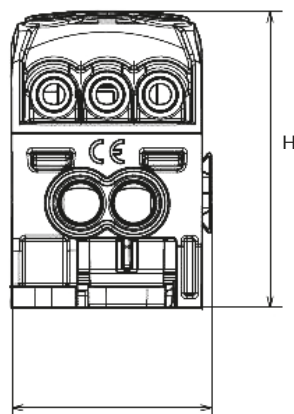

4.4

DISTRIBUTION BLOCKS ShNK® modular





Compliance with standards:

- EN 60947-1
- EN 60947-7-1
- EN 60947-7-2
- LVD 2014/35/UE

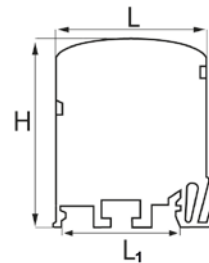
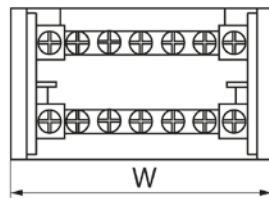
	ShNK 2x7	ShNK 2x11	ShNK 2x15
	$2 \times \begin{pmatrix} 5 \times 6 \text{ mm}^2 \\ 2 \times 25 \text{ mm}^2 \end{pmatrix}$	$2 \times \begin{pmatrix} 7 \times 6 \text{ mm}^2 \\ 2 \times 25 \text{ mm}^2 \\ 2 \times 35 \text{ mm}^2 \end{pmatrix}$	$2 \times \begin{pmatrix} 11 \times 6 \text{ mm}^2 \\ 2 \times 25 \text{ mm}^2 \\ 2 \times 35 \text{ mm}^2 \end{pmatrix}$
Colour Cat. No.	85 140 002	85 146 002	85 141 002
Nominal cross-sections			
wire	5 x (2,5 ... 6mm ²) / 2 x (10 ... 25mm ²)	7 x (2,5 ... 6mm ²) / 2 x (10 ... 25mm ²) / 2 x (10 ... 35mm ²)	11 x (2,5 ... 6 mm ²) / 2 x (10 ... 25mm ²) / 2 x (10 ... 35 mm ²)
stranded line	5 x (1,5 ... 6mm ²) / 2 x (6 ... 16mm ²)	7 x (1,5 ... 6mm ²) / 2 x (6 ... 16mm ²) / 2 x (10 ... 16mm ²)	11 x (1,5 ... 6mm ²) / 2 x (6 ... 16mm ²) / 2 x (10 ... 16mm ²)
IP rating	IP20	IP20	IP20
Rated voltage AC [U _i]	500 V	500 V	500 V
Rated current [I _e]	125 A (40 °C)	125 A (40 °C)	125 A (40 °C)
Rated short-circuit current [I _{pk}]	20 kA	20 kA	20 kA
Set screw bolts	M5	M5	M5
Tightening torque	2 Nm	2 Nm	2 Nm
Permissible humidity [R _h]	≤ 90%	≤ 90%	≤ 90%
Ambient temperature	- 25 °C ... 40 °C	- 25 °C ... 40 °C	- 25 °C ... 40 °C
Material	cover - PC / body - PA / rail - brass	cover - PC / body - PA / rail - brass	cover - PC / body - PA / rail - brass
External dimensions			
W / H / L / L ₁ [mm]	65,5 / 51 / 41 / 35	100 / 51 / 41 / 35	133 / 51 / 41 / 35
Mounting			
W / H / L / L ₁ [mm]	TS 35 / for mounting plate	TS 35 / for mounting plate	TS 35 / for mounting plate
Collective packaging*			

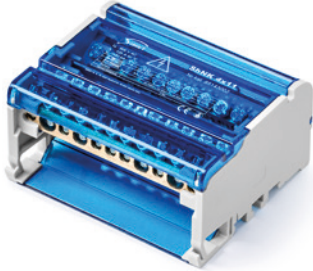

- Compliance with standards:
- EN 60947-1
 - EN 60947-7-1
 - EN 60947-7-2
 - LVD 2014/35/UE

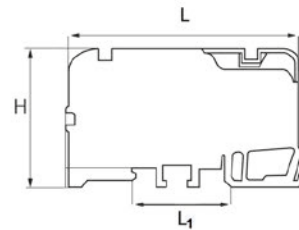
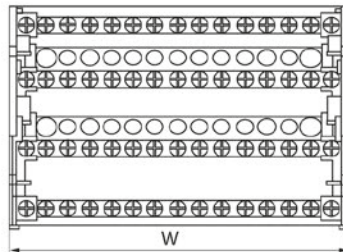

	ShNK 4x7	ShNK 4x11
		
	$4 \times \left(\begin{matrix} 5 \times 6 \text{ mm}^2, \\ 2 \times 25 \text{ mm}^2 \end{matrix} \right)$	$4 \times \left(\begin{matrix} 7 \times 6 \text{ mm}^2, \\ 2 \times 25 \text{ mm}^2, \\ 2 \times 35 \text{ mm}^2 \end{matrix} \right)$
Colour Cat. No.	85 142 002	85 143 002
Nominal cross-sections		
wire	5 x (2,5 ... 6mm ²) / 2 x (10 ... 25mm ²)	7 x (2,5 ... 6mm ²) / 2 x (10 ... 25mm ²) / 2 x (10 ... 35mm ²)
stranded line	5 x (1,5 ... 6mm ²) / 2 x (6 ... 16mm ²)	7 x (1,5 ... 6mm ²) / 2 x (6 ... 16mm ²) / 2 x (10 ... 16mm ²)
IP rating	IP20	IP20
Rated voltage AC [U]	500 V	500 V
Rated current [I _e]	125 A (40 °C)	125 A (40 °C)
Rated short-circuit current [I _{pk}]	20 kA	20 kA
Set screw bolts	M5	M5
Tightening torque	2 Nm	2 Nm
Permissible humidity [R _n]	≤ 90%	≤ 90%
Ambient temperature	- 25 °C ... 40 °C	- 25 °C ... 40 °C
Material	cover - PC / body - PA / rail - brass	cover - PC / body - PA / rail - brass
External dimensions		
W / H / L / L ₁ [mm]	65,5 / 50 / 84 / 35	100,2 / 50 / 84 / 35
Mounting		
W / H / L / L ₁ [mm]	TS 35 / for mounting plate	TS 35 / for mounting plate
Collective packaging*		



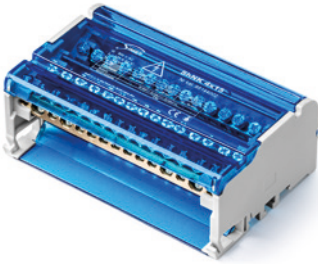
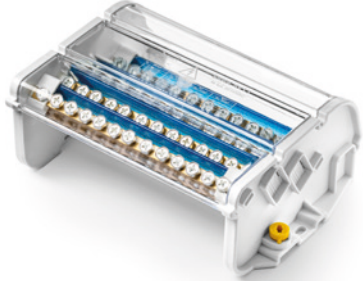

Compliance with standards:

- EN 60947-1
- EN 60947-7-1
- EN 60947-7-2
- LVD 2014/35/UE

	ShNK 4x15	ShNK 4x13
		
	$4 \times \begin{pmatrix} 11 \times 6 \text{ mm}^2, \\ 2 \times 25 \text{ mm}^2, \\ 2 \times 35 \text{ mm}^2 \end{pmatrix}$	$4 \times \begin{pmatrix} 8 \times 25 \text{ mm}^2, \\ 4 \times 35 \text{ mm}^2, \\ 1 \times 50 \text{ mm}^2 \end{pmatrix}$
Colour Cat. No.	85 144 002	85 145 002
Nominal cross-sections		
wire	11 x (2,5 ... 6mm ²) / 2 x (10 ... 25mm ²) / 2 x (10 ... 35mm ²)	8 x (10 ... 25mm ²) / 4 x (10 ... 25mm ²) / 1 x (35 ... 50mm ²)
stranded line	11 x (1,5 ... 6mm ²) / 2 x (6 ... 16mm ²) / 2 x (10 ... 16mm ²)	8 x (6 ... 16mm ²) / 4 x (10 ... 16mm ²) / 1 x (25 ... 35mm ²)
IP rating	IP20	IP20
Rated voltage AC [U]	500 V	500 V
Rated current [I _e]	125 A (40 °C)	160 A (40 °C)
Rated short-circuit current [I _{pk}]	20 kA	20 kA
Set screw bolts	M5	M5
Tightening torque	2 Nm	2,5 Nm
Permissible humidity [R _n]	≤ 90%	≤ 90%
Ambient temperature	- 25 °C ... 40 °C	- 25 °C ... 40 °C
Material	cover - PC / body - PA / rail - brass	cover - PC / body - PA / rail - brass
External dimensions		
W / H / L / L ₁ [mm]	132 / 50 / 84 / 35	182,4 / 73,5 / 137,5 / 35
Mounting		
W / H / L / L ₁ [mm]	TS 35 / for mounting plate	TS 35 / for mounting plate
Collective packaging*		

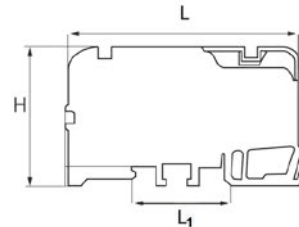
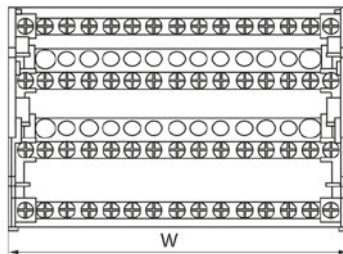

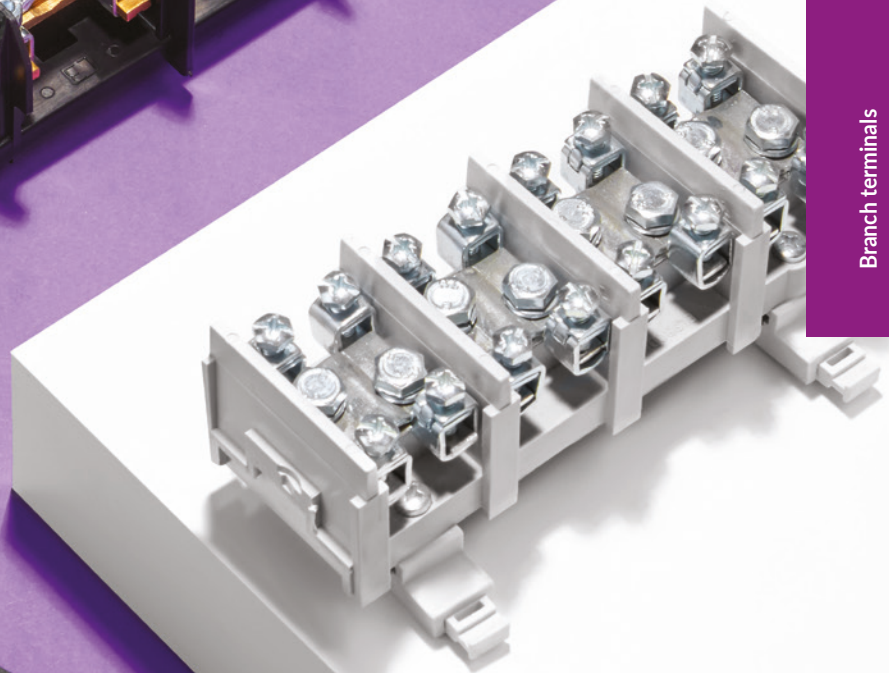
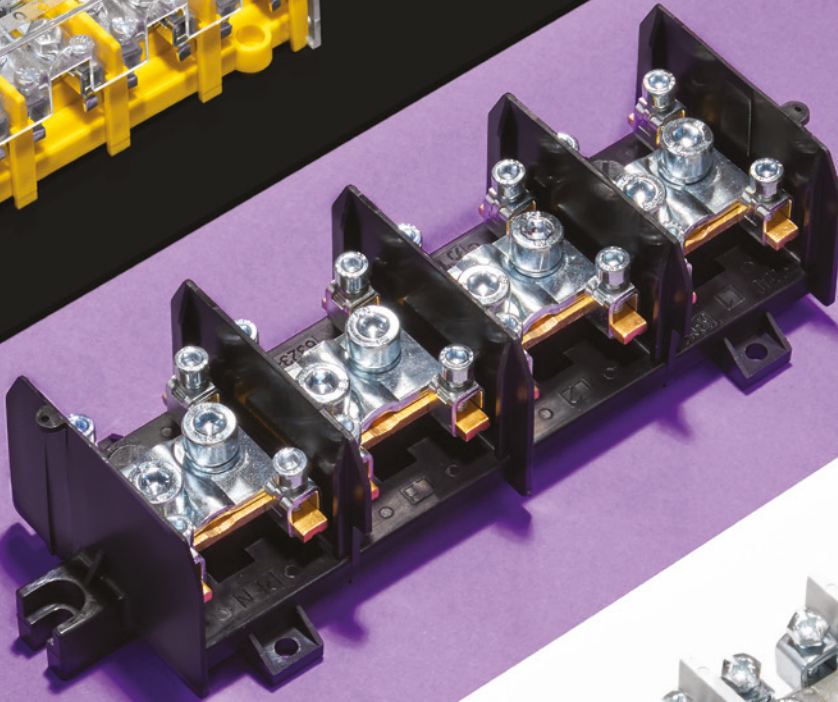
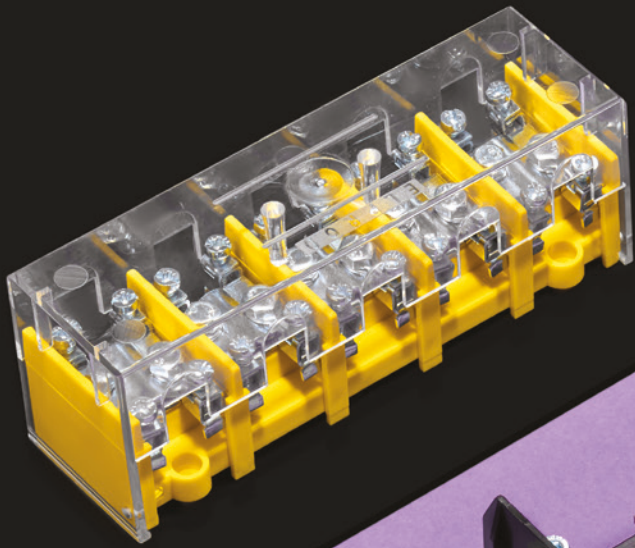







BRANCH TERMINALS

5.1

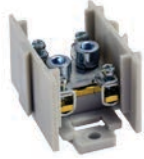



BRANCH TERMINALS

single pole



	LZ 1*25/6	LZ 1*35/16 wyk.11	LZ 1*35/16 wyk.12
			
	25 mm²/4x6 mm²	35 mm²/4x16 mm²	2x35 mm²/4x16 mm²
Colour Cat. No.			
Grey ○	84 101 002	84 104 002	84 115 002
Current data			
Rated voltage	500 V	450 V	450 V
Rated current	101 A	125 A	125 A
External dimensions			
Dimensions A / B / C [mm]	42 / 35 / 55	41 / 43 / 49	41 / 53 / 49
Quantity x rated cross-section			
Solid wire	1 x (4 ... 25 mm ²); 4 x (1,5 ... 6 mm ²)	1 x (6 ... 35 mm ²); 4 x (2,5 ... 16 mm ²)	2 x (6 ... 35 mm ²); 4 x (2,5 ... 16 mm ²)
Stranded wire	1 x (4 ... 16 mm ²); 4 x (1,5 ... 4 mm ²)	1 x (6 ... 25 mm ²); 4 x (2,5 ... 10 mm ²)	2 x (6 ... 25 mm ²); 4 x (2,5 ... 10 mm ²)
Mounting	to the substrate and to TS 35 rail	to the substrate	to the substrate
Weight	63 g	100 g	111 g
Standard	IEC 60998-2-1	IEC 60998-2-1	IEC 60998-2-1
Collective packaging			



	LZ 1*35/16 wyk.21	LZ 1*35/16 wyk.22
		
	35 mm²/4x16 mm²	2x35 mm²/4x16 mm²
Colour Cat. No.		
Grey ○	84 049 002	84 116 002
Current data		
Rated voltage	450 V	450 V
Rated current	125 A	125 A
External dimensions		
Dimensions A / B / C [mm]	41 / 69 / 49	41 / 79 / 49
Quantity x rated cross-section		
Solid wire	1 x (6 ... 35 mm ²); 4 x (2,5 ... 16 mm ²)	2 x (6 ... 35 mm ²); 4 x (2,5 ... 16 mm ²)
Stranded wire	1 x (6 ... 25 mm ²); 4 x (2,5 ... 10 mm ²)	2 x (6 ... 25 mm ²); 4 x (2,5 ... 10 mm ²)
Mounting	to the TS 35 rail	to the TS 35 rail
Weight	109 g	122 g
Standard	IEC 60998-2-1	IEC 60998-2-1
Collective packaging		



	LZ 1*70/16	LZ 1*70/16P
	70 mm²/4x16 mm²	70 mm²/4x16 mm²
Colour Cat. No.		
Grey ○	84 057 002	84 047 002
Blue ●	_____	84 047 003
Yellow-green ●●	_____	84 047 009
Current data		
Rated voltage	690 V	690 V
Rated current	192 A	192 A
External dimensions		
Dimensions A / B / C [mm]	56 / 50 / 79	56 / 51 / 79
Quantity x rated cross-section		
Solid wire	1 x (16 ... 70 mm ²); 4 x (2,5 ... 16 mm ²)	1 x (16 ... 70 mm ²); 4 x (6 ... 16 mm ²)
Stranded wire	1 x (16 ... 50 mm ²); 4 x (2,5 ... 10 mm ²)	1 x (16 ... 50 mm ²); 4 x (6 ... 10 mm ²)
Mounting	to the substrate and to TS 35 rail	to the substrate and to TS 35 rail
Additional information	-	with cover
Weight	173 g	184 g
Standard	IEC 60998-2-1	PN-EN 60947-1; PN-EN 60947-7-1
Collective packaging		



	LZ 1*95/35P	LZ 1*240/35/25P
	95 mm²/4x35 mm²	2x240 mm², 1x35 mm²/2x25 mm²
Colour Cat. No.		
Grey ○	84 063 002	84 002 002
Blue ●	84 063 003	_____
Yellow ●	84 063 004	_____
Yellow-green ●●	84 063 009	_____
Current data		
Rated voltage	690 V	690 V
Rated current	232 A	309 A
External dimensions		
Dimensions A / B / C [mm]	64 / 52 / 81	84 / 77 / 146
Quantity x rated cross-section		
Solid wire	1 x (25 ... 95 mm ²); 4 x (4 ... 35 mm ²)	2 x (35 ... 240 mm ²); 1 x (16 ... 35 mm ²); 2 x (10 ... 25 mm ²)
Stranded wire	1 x (25 ... 70 mm ²); 4 x (4 ... 25 mm ²)	2 x (35 ... 120 mm ²); 1 x (16 ... 35 mm ²); 2 x (10 ... 25 mm ²)
Mounting	to the substrate and to TS 35 rail	directly to the substrate
Additional information	with cover	with cover / ring lug
Weight	249 g	557 g
Standard	PN-EN 60947-1; PN-EN 60947-7-1	IEC 60998-2-1
Collective packaging		

5.1

BRANCH TERMINALS

four-pole



LZ 4*35/16 wyk.11 (Without cover)	LZ 4*35/16 wyk.11P (With cover)	LZ 4*35/16 wyk.21 (Without cover)	LZ 4*35/16 wyk.21P (With cover)
--------------------------------------	------------------------------------	--------------------------------------	------------------------------------

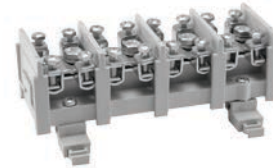
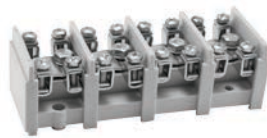

	35 mm ² /4x16 mm ²	35 mm ² /4x16 mm ²
Colour Cat. No.		
Grey ○	84 172 002	84 173 002
Grey ○	84 174 002 (with cover)	84 175 002 (with cover)
Current data		
Rated voltage	450 V	450 V
Rated current	125 A	125 A
External dimensions		
Dimensions A / B / C [mm]	50 / 43 / 143 50 / 61 / 143 with cover	50 / 54 / 143 50 / 72 / 143 with cover
Quantity x rated cross-section		
Solid wire	1 x (6 ... 35 mm ²); 4 x (2,5 ... 16 mm ²)	1 x (6 ... 35 mm ²); 4 x (2,5 ... 16 mm ²)
Stranded wire	1 x (6 ... 25 mm ²); 4 x (2,5 ... 10 mm ²)	1 x (6 ... 25 mm ²); 4 x (2,5 ... 10 mm ²)
Mounting	to the substrate	to the TS 35 rail
Weight	361 g without cover / 428 g with cover	373 g without cover / 441 g with cover
Standard	IEC 60998-2-1	IEC 60998-2-1
Collective packaging		

LZ 4*25/6 (Without cover)	LZ 4*25/6P (With cover)	LZ 4*70/16
------------------------------	----------------------------	------------



	25 mm ² /4x6 mm ²	70 mm ² /4x16 mm ²
Colour Cat. No.		
Grey ○	84 106 002	_____
Grey ○	84 171 002 (with cover)	_____
Black ●	_____	84 056 007
Current data		
Rated voltage	450 V	690 V
Rated current	101 A	192 A
External dimensions		
Dimensions A / B / C [mm]	55 / 35 / 149 55 / 38 / 149 with cover	80 / 49 / 230
Quantity x rated cross-section		
Solid wire	1 x (4 ... 25 mm ²); 4 x (1,5 ... 6 mm ²)	1 x (16 ... 70 mm ²); 4 x (2,5 ... 16 mm ²)
Stranded wire	1 x (4 ... 16 mm ²); 4 x (1,5 ... 4 mm ²)	1 x (16 ... 50 mm ²); 4 x (2,5 ... 10 mm ²)
Mounting	to the substrate and to TS 35 rail	to the substrate and to TS 35 rail
Weight	236 g without cover / 271 g with cover	686 g
Standard	IEC 60998-2-1	IEC 60998-2-1
Collective packaging		

Note: Branch terminal blocks of LZ series are characterised by the possibility of pass-through installation of the main wire. This means the wire can be mounted in every branching pole (without cutting it) with the use of pressing plate to the current circuit. Similarly as in LZ1*70/16 terminal block, we can mount the wire under the crease in the central part of the plate with a cross-section up to 70 mm².

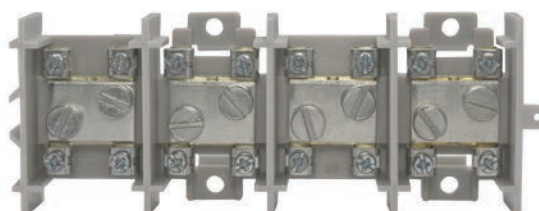



	LZ 5*25/10 wyk.11 (Without cover)	LZ 5*25/10 wyk.11P (With cover)	LZ 5*25/10 wyk.12 (Without cover)	LZ 5*25/10 wyk.12P (With cover)
	25 mm²/4x10 mm²		2x25 mm²/4x10 mm²	
Colour Cat. No.				
Yellow ●	84 107 004		84 084 004	
Yellow ●	84 061 004 (with cover)		84 167 004 (with cover)	
Current data				
Rated voltage	450 V		450 V	
Rated current	101 A		101 A	
External dimensions				
Dimensions A / B / C [mm]	47 / 37 / 148 47 / 56 / 148 with cover		47 / 51 / 148 47 / 56 / 148 with cover	
Quantity x rated cross-section				
Solid wire	1 x (6 ... 25 mm ²); 4 x (0,75 ... 10 mm ²)		1 x (6 ... 25 mm ²); 4 x (0,75 ... 10 mm ²)	
Stranded wire	1 x (6 ... 16 mm ²); 4 x (0,75 ... 6 mm ²)		1 x (6 ... 16 mm ²); 4 x (0,75 ... 6 mm ²)	
Mounting	to the substrate		to the substrate	
Weight	270 g without cover / 309 g with cover		316 g without cover / 355 g with cover	
Standard	PN-EN 60947-1; PN-EN 60947-7-1; PN-EN 50581		PN-EN 60947-1; PN-EN 60947-7-1; PN-EN 50581	
Collective packaging				



	LZ 5*25/10 wyk.21 (Without cover)	LZ 5*25/10 wyk.21P (With cover)	LZ 5*25/10 wyk.22 (Without cover)	LZ 5*25/10 wyk.22P (With cover)
	25 mm²/4x10 mm²		2x25 mm²/4x10 mm²	
Colour Cat. No.				
Yellow ●	84 108 004		84 050 004	
Yellow ●	84 062 004 (with cover)		84 095 004 (with cover)	
Current data				
Rated voltage	450 V		450 V	
Rated current	101 A		101 A	
External dimensions				
Dimensions A / B / C [mm]	47 / 61 / 148 47 / 80 / 148 with cover		47 / 76 / 148 47 / 80 / 148 with cover	
Quantity x rated cross-section				
Solid wire	1 x (6 ... 25 mm ²); 4 x (0,75 ... 10 mm ²)		1 x (6 ... 25 mm ²); 4 x (0,75 ... 10 mm ²)	
Stranded wire	1 x (6 ... 16 mm ²); 4 x (0,75 ... 6 mm ²)		1 x (6 ... 16 mm ²); 4 x (0,75 ... 6 mm ²)	
Mounting	to the TS 35 rail		to the TS 35 rail	
Weight	286 g without cover / 325 g with cover		331 g without cover / 370 g with cover	
Standard	PN-EN 60947-1; PN-EN 60947-7-1; PN-EN 50581		PN-EN 60947-1; PN-EN 60947-7-1; PN-EN 50581	
Collective packaging				

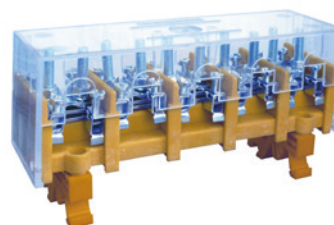

5.1

BRANCH TERMINALS

five-pole



	LZ5*35/16 wyk.11 (Without cover)	LZ5*35/16 wyk.11P (With cover)	LZ5*35/16 wyk.12 (Without cover)	LZ5*35/16 wyk.12P (With cover)
	35 mm²/4x16 mm²		5x(35 mm²/4x16 mm²)	
Colour Cat. No.				
Grey ○	84 025 002		84 026 002	
Grey ○	84 034 002 (with cover)		84 036 002 (with cover)	
Current data				
Rated voltage	450 V		450 V	
Rated current	125 A		125 A	
External dimensions				
Dimensions A / B / C [mm]	49 / 43 / 174 49 / 61 / 174 with cover		49 / 53 / 174 49 / 61 / 174 with cover	
Quantity x rated cross-section				
Solid wire	1 x (6 ... 35 mm ²); 4 x (2,5 ... 16 mm ²)		2 x (6 ... 35 mm ²); 4 x (2,5 ... 16 mm ²)	
Stranded wire	1 x (6 ... 25 mm ²); 4 x (2,5 ... 10 mm ²)		2 x (6 ... 25 mm ²); 4 x (2,5 ... 10 mm ²)	
Mounting	to the substrate		to the substrate	
Weight	456 g without cover / 502 g with cover		513 g without cover / 575 g with cover	
Standard	IEC 60998-2-1		IEC 60998-2-1	
Collective packaging				





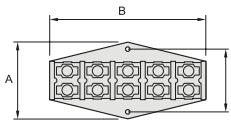

	LZ5*35/16 wyk.21 (Without cover)	LZ5*35/16 wyk.21P (With cover)	LZ5*35/16 wyk.22 (Without cover)	LZ5*35/16 wyk.22P (With cover)
	35 mm²/4x16 mm²		2x35 mm²/4x16 mm²	
Colour Cat. No.				
Grey ○	84 027 002		84 028 002	
Grey ○	84 035 002 (with cover)		84 037 002 (with cover)	
Current data				
Rated voltage	450 V		450 V	
Rated current	125 A		125 A	
External dimensions				
Dimensions A / B / C [mm]	49 / 69 / 174 49 / 86 / 174 with cover		49 / 79 / 174 49 / 86 / 174 with cover	
Quantity x rated cross-section				
Solid wire	1 x (6 ... 35 mm ²); 4 x (2,5 ... 16 mm ²)		2 x (6 ... 35 mm ²); 4 x (2,5 ... 16 mm ²)	
Stranded wire	1 x (6 ... 25 mm ²); 4 x (2,5 ... 10 mm ²)		2 x (6 ... 25 mm ²); 4 x (2,5 ... 10 mm ²)	
Mounting	to the substrate		to the substrate	
Weight	482 g without cover / 531 g with cover		532 g without cover / 594 g with cover	
Standard	IEC 60998-2-1		IEC 60998-2-1	
Collective packaging				

Note: Branch terminal blocks of LZ series are characterised by the possibility of pass-through installation of the main wire. This means the wire can be mounted in every branching pole (without cutting it) with the use of pressing plate to the current circuit.

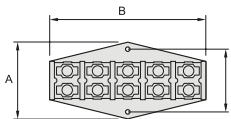

	ZPT4-2.5	ZPT4-4.0
		
	4x(4x2,5 mm²)	4x(4x4 mm²)
Colour Cat. No.		
Black ●	83 001 007	83 003 007
Number of poles	4	4
Number of conductors / cross-section	4x2,5 mm ²	4x4 mm ²
Current data		
Rated voltage	450 V	400 V
Rated current	10 A	24 A
External dimensions		
A / B / C / D [mm]	42 / 43 / 39 / 19	56 / 52 / 39 / 21
Weight	20 g	30 g
Standard	PN-EN 60998-1	PN-EN 60998-1
Collective packaging		



	ZPT4-10.0	ZPT4-16.0	ZPT4-35.0
			
	4x(4x10 mm²)	4x(4x16 mm²)	4x(4x35 mm²)
Colour Cat. No.			
Black ●	83 005 007	83 007 007	83 009 007
Number of poles	4	4	4
Number of conductors / cross-section	4x10 mm ²	4x16mm ²	2x35 mm ²
Current data			
Rated voltage	400 V	400 V	500 V
Rated current	40 A	55 A	85 A
External dimensions			
A / B / C / D [mm]	56 / 72 / 44 / 21	65 / 102 / 63 / 22	58 / 116 / 55 / 34
Weight	70 g	120 g	200 g
Standard	PN-EN 60998-1	PN-EN 60947-1; PN-EN 50581	PN-EN 60998-1
Collective packaging			

Note: Possibility of installation in the pass-through system.

5.2

DISTRIBUTION CONNECTORS five-pole

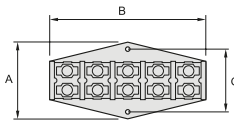

	ZPT5-2.5	ZPT5-4.0
	5x(4x2,5 mm²)	5x(4x4 mm²)
Colour Cat. No.		
Black ●	83 002 007	83 004 007
Number of poles	5	5
Number of conductors / cross-section	4x2,5 mm ²	4x4 mm ²
Current data		
Rated voltage	450 V	400 V
Rated current	10 A	24 A
External dimensions		
A / B / C / D [mm]	42 / 53 / 39 / 19	56 / 69 / 39 / 21
Weight	30 g	30 g
Standard	PN-EN 60947-1; PN-EN 50581	PN-EN 60947-1; PN-EN 50581
Collective packaging		

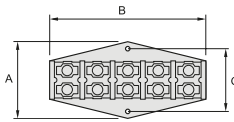

	ZPT5-10.0	ZPT5-16.0	ZPT5-35.0
	5x(4x10 mm²)	5x(4x16 mm²)	5x(2x35 mm²)
Colour Cat. No.			
Black ●	83 006 007	83 008 007	83 010 007
Number of poles	5	5	5
Number of conductors / cross-section	4x10 mm ²	4x16 mm ²	2x35 mm ²
Current data			
Rated voltage	400 V	400 V	500 V
Rated current	40 A	55 A	85 A
External dimensions			
A / B / C / D [mm]	56 / 88 / 44 / 21	73 / 126 / 63 / 22	58 / 140 / 80 / 34
Weight	90 g	150 g	250 g
Standard	PN-EN 60947-1; PN-EN 50581	PN-EN 60998-1	PN-EN 60998-1
Collective packaging			

Note: Possibility of installation in the pass-through system.

CONNECTOR STRIPS

6.1

CONNECTOR STRIPS

Orange series - LTF

PE

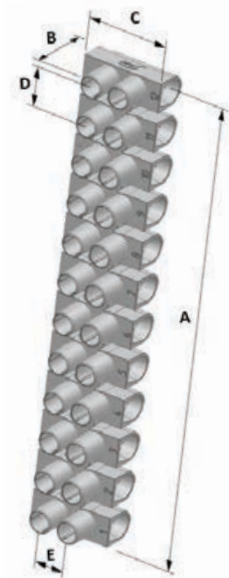

LTF12-2.5

LTF12-4.0

LTF12-6.0

A
24

A
32

A
41



	2,5 mm ²	4 mm ²	6 mm ²
Colour Cat. No.			
Orange ●	21 210 108	21 310 108	21 412 108
Rated cross-section	2,5	4	6
Solid wire	1 ... 2,5 mm ²	1,5 ... 4 mm ²	2,5 ... 6 mm ²
Stranded wire	1 ... 2,5 mm ²	1,5 ... 4 mm ²	1,5 ... 4 mm ²
Operating temperature	-25 °C ... +55 °C	-25 °C ... +55 °C	-25 °C ... +55 °C
Body material	polyethylene	polyethylene	polyethylene
Current data			
Rated voltage	450 V	450 V	450 V
Rated current	24 A	32 A	41 A
External dimensions			
A / B / C / D / E [mm]	94 / 13 / 16 / 8 / 6	106 / 14 / 18 / 9 / 7	118 / 15 / 19 / 9 / 7
Stripped wire length	5 mm	6 mm	6 mm
Set screw - bolt	M3	M3	M3
Mounting to the substrate	M2,5x10	M3x14	M3x14
Weight	23 g	31 g	33 g
Clamp	brass	brass	brass
Standard	PN-EN 60998-1 PN-EN 60998-2-1	PN-EN 60998-1 PN-EN 60998-2-1	PN-EN 60998-1 PN-EN 60998-2-1
Collective packaging			

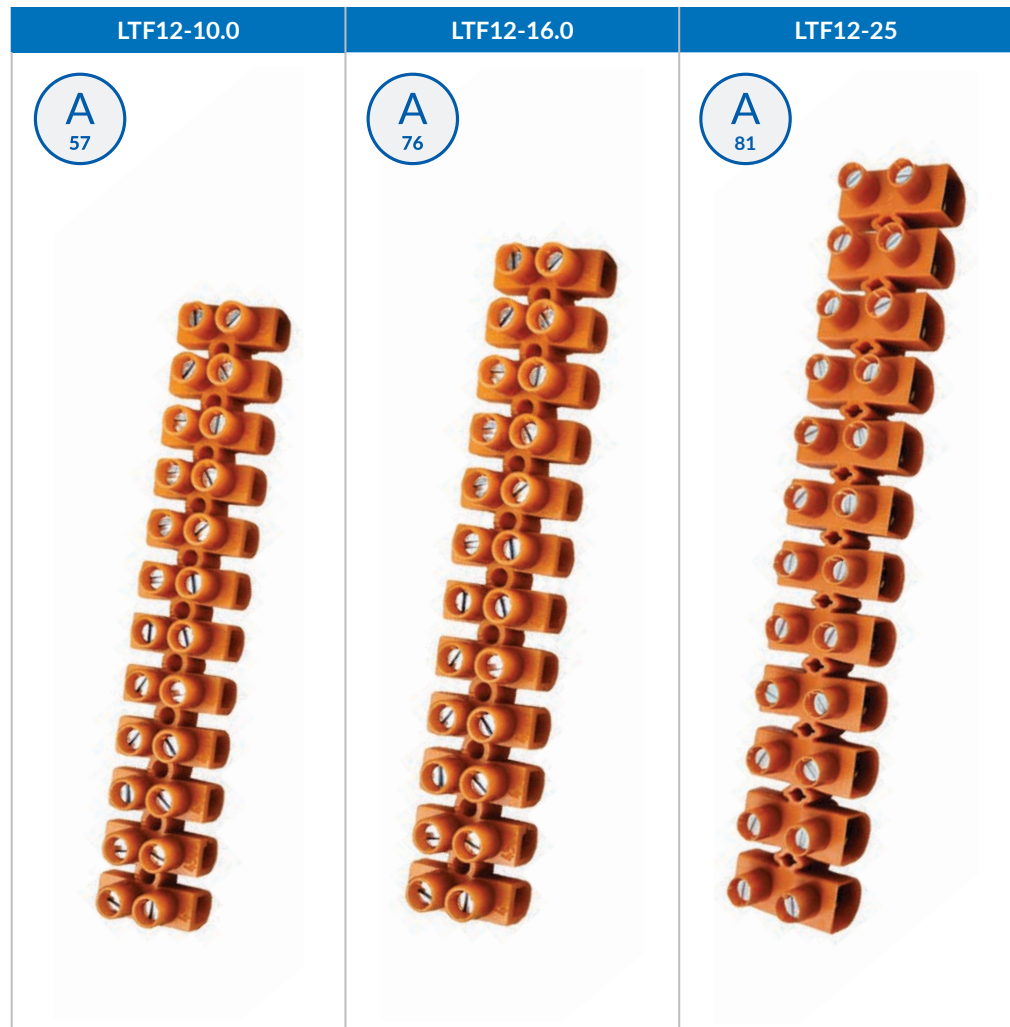
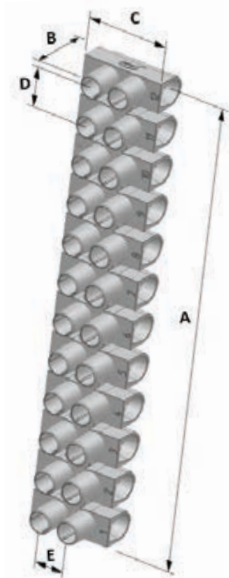

	LTF12-10.0	LTF12-16.0	LTF12-25
	10 mm²	16 mm²	25 mm²
Colour Cat. No.			
Orange	21 512 108	21 612 108	21 712 108
Rated cross-section	10	16	25
Solid wire	4 ... 10 mm ²	6 ... 16 mm ²	10 ... 25 mm ²
Stranded wire	2,5 ... 6 mm ²	4 ... 10 mm ²	6 ... 16 mm ²
Operating temperature	-25 °C ... +55 °C	-25 °C ... +55 °C	-40 °C ... +85 °C
Body material	polyethylene	polyethylene	flame retardant polyethylene
Current data			
Rated voltage	750 V	750 V	750 V
Rated current	57 A	76 A	81 A
External dimensions			
A / B / C / D / E [mm]	141 / 20 / 25 / 12 / 9	153 / 21,6 / 27 / 13 / 10	210 / 24,6 / 33 / 18 / 16
Stripped wire length	8 mm	8,5 mm	8,5 mm
Set screw - bolt	M4	M5	M5
Mounting to the substrate	M4x18	M4x18	M4x18
Weight	69 g	95 g	151 g
Clamp	brass	brass	brass
Standard	PN-EN 60998-1 PN-EN 60998-2-1	PN-EN 60998-1 PN-EN 60998-2-1	PN-EN 60998-1 PN-EN 60998-2-1
Collective packaging			

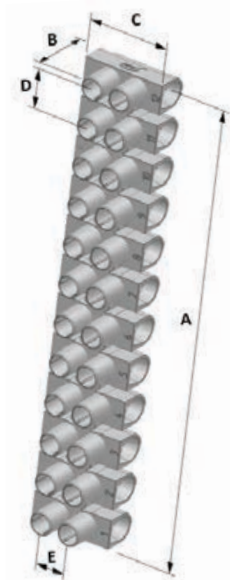

	LTA12-2.5	LTA12-4.0	LTA12-6.0

	2,5 mm ²	4 mm ²	6 mm ²
Colour Cat. No.			
White ○	22 210 216	22 310 216	22 412 216
Black ●	22 210 217	22 310 217	22 412 217
Rated cross-section	2,5	4	6
Solid wire	0,75 ... 2,5 mm ²	1,5 ... 4 mm ²	2,5 ... 6 mm ²
Stranded wire	0,75 ... 2,5 mm ²	1,5 ... 2,5 mm ²	2,5 ... 4 mm ²
Operating temperature	-25 °C ... +125 °C	-25 °C ... +125 °C	-25 °C ... +125 °C
Body material	halogen-free polyamide PA 6	halogen-free polyamide PA 6	halogen-free polyamide PA 6
Current data			
Rated voltage	450 V	450 V	450 V
Rated current	24 A	32 A	41 A
Rated voltage [U _{imp}]	4 kV	4 kV	4 kV
External dimensions			
A / B / C / D / E [mm]	94 / 13 / 16 / 8 / 6	105,5 / 14 / 18 / 9 / 7	117,4 / 14,5 / 19 / 10 / 7
Stripped wire length	5 mm	6 mm	6 mm
Set screw - bolt	M3	M3	M3
Mounting to the substrate	M2,5x10	M3x14	M3x14
Weight	22,7 g	32,4 g	39,9 g
Clamp	galvanised brass	galvanised brass	galvanised brass
Standard	PN-EN 60947-1 PN-EN 60947-7-1	PN-EN 60947-1 PN-EN 60947-7-1	PN-EN 60947-1 PN-EN 60947-7-1
Collective packaging			

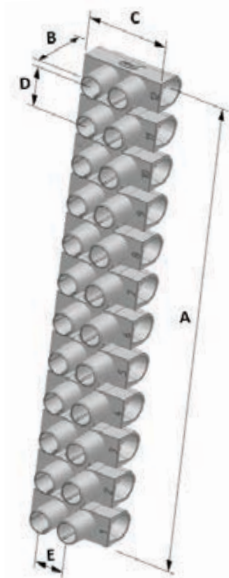

	LTA12-10.0	LTA12-16.0	EKL5E
	A 57	A 76	
	10 mm²	16 mm²	35 mm²
Colour Cat. No.			
White ○	22 512 216	22 612 216	—
Black ●	22 512 217	22 612 217	89 150 007
Rated cross-section	10	16	35
Solid wire	4 ... 10 mm ²	6 ... 16 mm ²	16 ... 35 mm ²
Stranded wire	4 ... 6 mm ²	6 ... 10 mm ²	16 ... 35 mm ²
Operating temperature	-25 °C ... +125 °C	-25 °C ... +125 °C	-25 °C ... +85 °C
Body material	halogen-free polyamide PA 6	halogen-free polyamide PA 6	polypropylene
Current data			
Rated voltage	750 V	750 V	750 V
Rated current	57 A	76 A	
Rated voltage [U _{imp}]	6 kV	6 kV	
External dimensions			
A / B / C / D / E [mm]	141 / 21 / 21 / 12 / 10	153 / 22 / 22 / 13 / 10	211 / 29,6 / 36,4 / 18 / 15
Stripped wire length	8 mm	8,5 mm	12 mm
Set screw - bolt	M4	M5	M5
Mounting to the substrate	M3x14	M4x18	M4
Weight	66,6 g	94,1 g	208 g
Clamp	galvanised brass	galvanised brass	brass
Standard	PN-EN 60947-1 PN-EN 60947-7-1	PN-EN 60947-1 PN-EN 60947-7-1	PN-EN 60998-2-1 PN-EN 60998-1
Collective packaging	100 	50 	10

PA 6

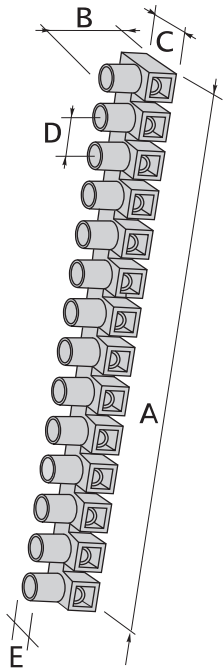

LTA12-4.0A

LTA12-4.0B

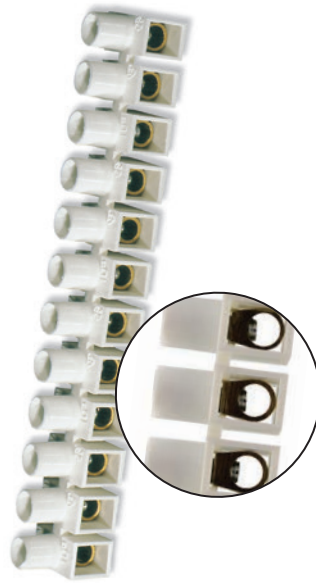
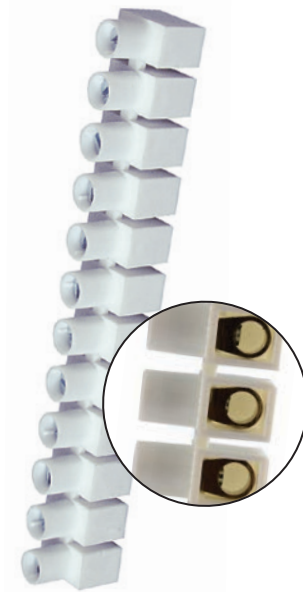
A
32A
32through 4 mm²one-side closed 4 mm²

Colour Cat. No.		
White ○	22 522 216	22 316 216
Rated cross-section	4	4
Solid wire	4 mm ²	4 mm ²
Stranded wire	4 mm ²	4 mm ²
Operating temperature	-25 °C ... +85 °C	-25 °C ... +85 °C
Body material	polyamide PA 6, halogen-free	polyamide PA 6, halogen-free
Current data		
Rated voltage	400 V	400 V
Rated current	32 A	32 A
External dimensions		
A / B / C / D / E [mm]	118 / 18 / 14,5 / 10 / -	118 / 18 / 14,5 / 10 / -
Stripped wire length	6 mm	6 mm
Set screw - bolt	M4	M4
Weight	37,7 g	43,0 g
Clamp	galvanised brass	galvanised brass
Additional information	pass-through with 1 screw / current circuit	pass-through with 1 screw / current circuit
Standard	PN-EN 60998-2-1 PN-EN 60998-1	PN-EN 60998-2-1 PN-EN 60998-1
Collective packaging		

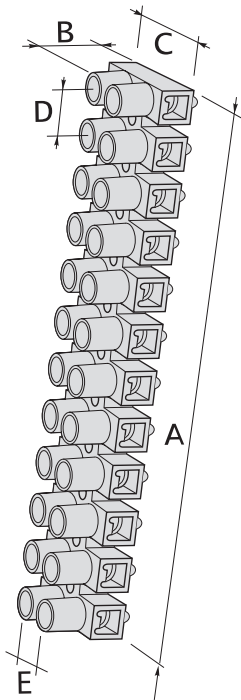

	LPA12-1.5	LPA12-2.5

	1,5 mm ²	2,5 mm ²
Colour Cat. No.		
Transparent <input type="radio"/>	89 091 110	89 092 110
Rated cross-section	1,5	2,5
Solid wire	0,75 ... 1,5 mm ²	1 ... 2,5 mm ²
Stranded wire	1,5 mm ²	2,5 mm ²
Current data		
Rated voltage	450 V	450 V
Rated current	17,5 A	24 A
Operating temperature	-30 °C ... +110 °C	-30 °C ... +110 °C
Body material	polyamide PA 66	polyamide PA 66
External dimensions		
A / B / C / D / E [mm]	96,2 / 14,5 / 17 / 8,2 / -	117,5 / 16,4 / 20 / 10 / -
Stripped wire length	5 mm	6 mm
Set screw - bolt	M2,5	M3
Weight	25 g	34,5 g
Additional information	with a steel plate to protect the conductor	with a steel plate to protect the conductor
Standard	PN-EN 60998-1 PN-EN 60998-2-1	PN-EN 60998-1 PN-EN 60998-2-1
Collective packaging		

6.3

CONNECTOR STRIPS

Series with a pad LPA

PA 66

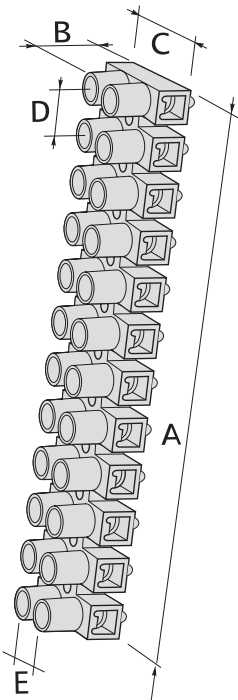

	4 mm ²	6 mm ²
Colour Cat. No.		
Transparent ○	89 089 110	89 093 110
Rated cross-section	4	6
Solid wire	1 ... 4 mm ²	2,5 ... 6 mm ²
Stranded wire	4 mm ²	6 mm ²
Current data		
Rated voltage	450 V	500 V
Rated current	32 A	41 A
Operating temperature	-30 °C ... +110 °C	-30 °C ... +110 °C
Body material	polyamide PA 66	polyamide PA 66
External dimensions		
A / B / C / D / E [mm]	116,8 / 16,7 / 19,2 / 10 / -	140,7 / 19 / 23,8 / 12 / -
Stripped wire length	7 mm	7 mm
Set screw - bolt	M3	M3
Weight	48 g	54,8 g
Additional information	with a steel plate to protect the conductor	with a steel plate to protect the conductor
Standard	PN-EN 60998	PN-EN 60998-1 PN-EN 60998-2-1
Collective packaging		

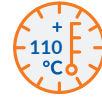

LPA12-10.0

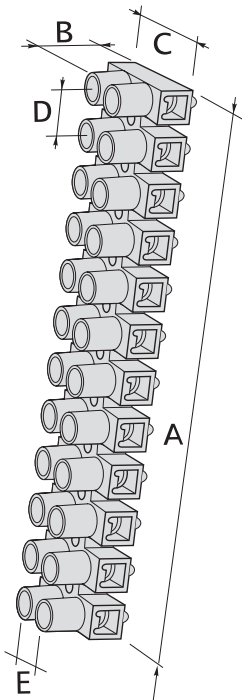

10 mm²

Colour Cat. No.	
Transparent ○	89 094 110
Rated cross-section	10
Solid wire	4 ... 10 mm ²
Stranded wire	10 mm ²
Current data	
Rated voltage	500 V
Rated current	57 A
Operating temperature	-30 °C ... +110 °C
Body material	polyamide PA 66
External dimensions	
A / B / C / D / E [mm]	158 / 25,2 / 25,6 / 13,5 / -
Stripped wire length	9 mm
Set screw - bolt	M4
Weight	90,4 g
Additional information	with a steel plate to protect the conductor
Standard	PN-EN 60998-1 PN-EN 60998-2-1
Collective packaging	

LTT 1

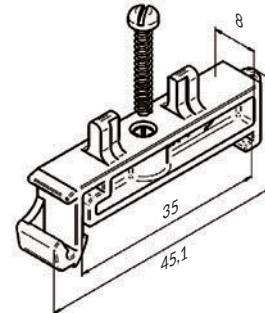
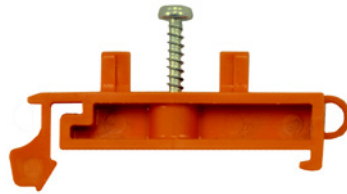

Colour | Cat. No.

Orange ●

26 210 008

Intended use
(terminal block symbol)

This holder enables the mounting of connector strips of extra orange series: LTF12-2.5; LTF12-4; LTF12-6 on a TS 35 rail

Collective packaging



LTT 2

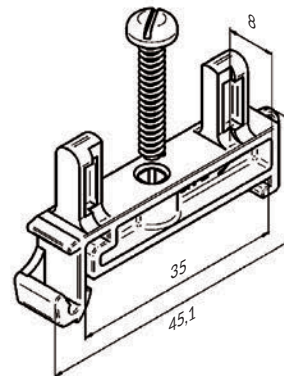

Colour | Cat. No.

Orange ●

26 512 008

Intended use
(terminal block symbol)

This holder enables the mounting of connector strips of extra orange series: LTF12-10; LTF12-16; LTF12-25 on a TS 35 rail

Collective packaging

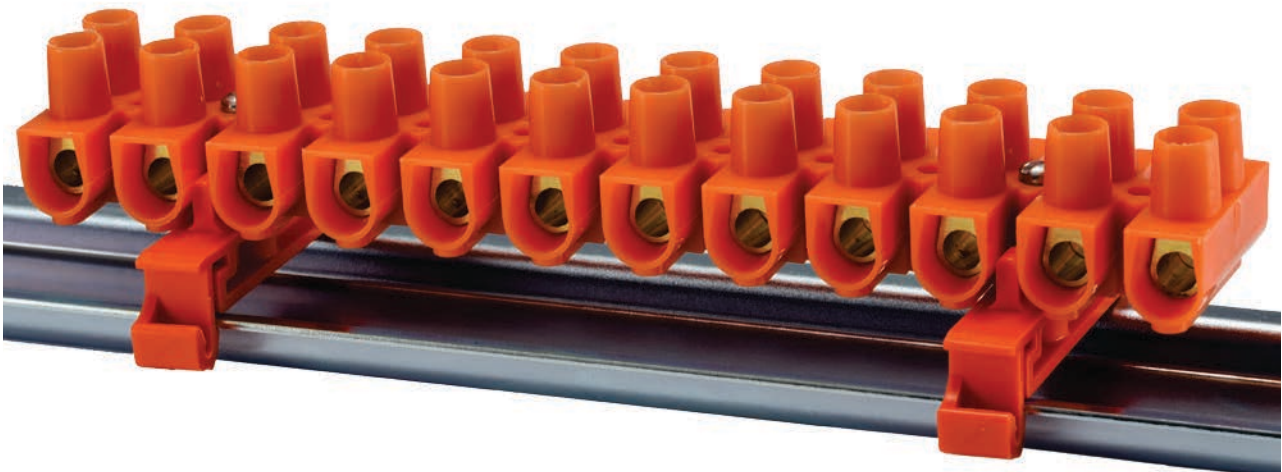

JUNCTION BOXES

7.1.1

FLUSH-MOUNTED JUNCTION BOXES Standard

PP

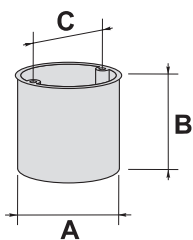

ZZ60KFw



ZZ60DFw



shallow, combined with screws **60 mm**

deep, combined with screws **60 mm**

Colour Cat. No.		
Orange ●	33 263 008	33 267 008
External dimensions		
A / B / C [mm]	66,5 / 41,8 / 60	66,5 / 63 / 60
Weight	16,3 g	21 g
Material properties	resistance to heat 650 °C	resistance to heat 650 °C
Additional features	this flush mounted junction box includes a possibility to create standard frame sets with a spacing of 71 mm, additional features connector KZ71 should be used in order to combine boxes in a series, knockout for the connector has a diameter of 25mm, two screws for fittings are included	
Accessories	connector KZ71, extension rings PD60x12; PD60x24; PD60x30, cover PL60; WS60, signalling cover PS60, screws W16; W25; W40	connector KZ71, extension rings PD60x12; PD60x24; PD60x30, cover PL60; WS60, signalling cover PS60, screws W16; W25; W40
Standard	PN-EN IEC 60670-1	PN-EN IEC 60670-1
Collective packaging		

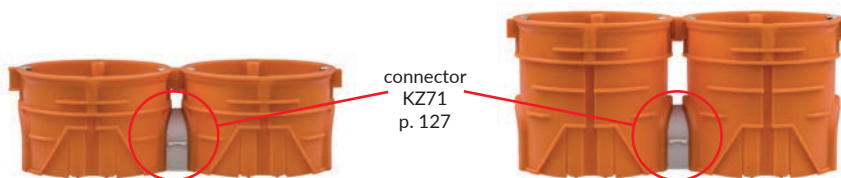

connector
KZ71
p. 127

PP

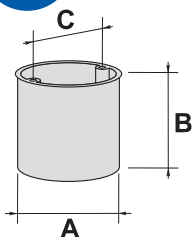

Z60KF



Z60KFw







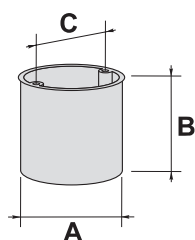

shallow **60 mm**

shallow, with screws **60 mm**

Colour Cat. No.		
Orange ●	33 048 008	33 049 008
External dimensions		
A / B / C [mm]	63 / 41 / 60	63 / 41 / 60
Weight	12,8 g	13,1 g
Material properties	resistance to heat 650 °C	resistance to heat 650 °C
Additional features	4 knockouts for pipes ø 20 mm in side walls, spacing for mounting fittings - 60 mm (C)	4 knockouts for pipes ø 20 mm in side walls, spacing for mounting fittings - 60 mm (C), 2 screws for mounting fittings are included
Accessories	extension rings PD60x12; PD60x24; PD60x30, cover PL60, WS60, signalling cover PS60, screws W16; W25; W40	extension rings PD60x12; PD60x24; PD60x30, cover PL60, WS60, signalling cover PS60, screws W16; W25; W40
Standard	PN-EN IEC 60670-1	PN-EN IEC 60670-1
Collective packaging		

PP



	Z60D	Z60Dw	Z60Kw
			
	deep 60 mm	deep, with screws 60 mm	shallow, with screws 60 mm
Colour Cat. No.			
Blue ●	34 033 203	34 035 203	34 049 203
External dimensions			
A / B / C [mm]	63 / 61 / 60	63 / 61 / 60	63 / 41 / 60
Weight	21,4 g	22,7 g	11,8 g
Material properties	self-extinguishing, halogen-free, resistance to heat 850 °C	self-extinguishing, halogen-free, resistance to heat 850 °C	self-extinguishing, halogen-free, resistance to heat 850 °C
Additional features	6 knockouts for pipes ø 20 mm in side walls, 1 knockout for pipe ø 20 mm in the bottom, spacing for mounting fittings - 60 mm (C), axis distance for drilling holes for the box - 71 mm	6 knockouts for pipes ø 20 mm in side walls, 1 knockout for pipe ø 20 mm in the bottom, spacing for mounting fittings - 60 mm (C), axis distance for drilling holes for the box - 71 mm, 2 screws for mounting fittings are included	4 knockouts for pipes ø 20 mm in side walls, spacing for mounting fittings - 60 mm (C), 2 screws for mounting fittings are included
Accessories	signalling cover PS60, protective cover WS60, PL60, extension rings PD 60x12; PD 60x24; PD60x30, screws W16; W25; W40	signalling cover PS60, protective cover WS60, PL60, extension rings PD 60x12; PD 60x24; PD60x30, screws W16; W25; W40	signalling cover PS60, protective cover WS60, PL60, extension rings PD 60x12; PD 60x24; PD60x30, screws W16; W25; W40
Standard	PN-EN IEC 60670-1	PN-EN IEC 60670-1	PN-EN IEC 60670-1
Collective packaging			

PP

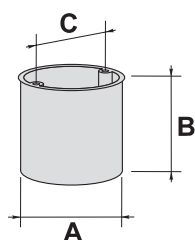

	Z60DF	Z60DFw
		
	deep 60 mm	deep, with screws 60 mm
Colour Cat. No.		
Orange ●	33 033 008	33 035 008
External dimensions		
A / B / C [mm]	63 / 61 / 60	63 / 61 / 60
Weight	21,4 g	20 g
Material properties	resistance to heat 650 °C	resistance to heat 650 °C
Additional features	8 knockouts for pipes ø 20 mm in side walls, 1 knockout for pipes ø 20 mm in the bottom, spacing for mounting fittings - 60 mm (C), axis distance for drilling holes for the box - 71 mm	8 knockouts for pipes ø 20 mm in side walls, 1 knockout for pipes ø 20 mm in the bottom, spacing for mounting fittings - 60 mm (C), axis distance for drilling holes for the box - 71 mm, 2 screws for mounting fittings are included
Accessories	extension rings PD60x12; PD60x24; PD60x30, cover PL60, WS60, screws W16; W25; W40	extension rings PD60x12; PD60x24; PD60x30, cover PL60, WS60, screws W16; W25; W40
Standard	PN-EN IEC 60670-1	PN-EN IEC 60670-1
Collective packaging		

7.1.1

FLUSH-MOUNTED JUNCTION BOXES

Standard

PP

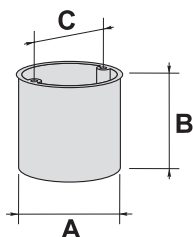

S60K



S60Kw



shallow, serial 60 mm

shallow, serial with screws 60 mm

Colour Cat. No.		
Blue ●	34 054 203	34 068 203
External dimensions		
A / B / C [mm]	65 / 41 / 60	65 / 41 / 60
Weight	18,3 g	19,6 g
Material properties	self-extinguishing, halogen-free, resistance to heat 850 °C	self-extinguishing, halogen-free, resistance to heat 850 °C
Additional features	8 knockouts for pipes ø 20 mm in side walls, 1 knockout in the box bottom, spacing for mounting fittings - 60 mm (C), axis distance for drilling holes for the box - 71 mm	8 knockouts for pipes ø 20 mm in side walls, 1 knockout in the box bottom, spacing for mounting fittings - 60 mm (C), axis distance for drilling holes for the box - 71 mm, 2 screws for mounting fittings are included
Accessories	signalling cover PS60, protective cover WS60; PL60, interconnector KD12, extension rings PD60x12; PD60x24; PD60x30, screws W16; W25; W40	signalling cover PS60, protective cover WS60; PL60, interconnector KD12, extension rings PD60x12; PD60x24; PD60x30, screws W16; W25; W40
Standard	PN-EN IEC 60670-1	PN-EN IEC 60670-1
Collective packaging		

PP

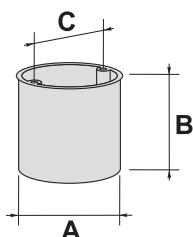

S60KF



S60KFw







shallow, serial 60 mm

shallow, serial with screws 60 mm

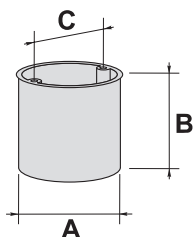
Colour Cat. No.		
Orange ●	33 054 008	33 068 008
External dimensions		
A / B / C [mm]	65 / 41 / 60	65 / 41 / 60
Weight	17,7 g	19 g
Material properties	resistance to heat 650 °C	resistance to heat 650 °C
Additional features	8 knockouts for pipes ø 20 mm in side walls, 1 knockout in the box bottom, spacing for mounting fittings - 60 mm (C), axis distance for drilling holes for the box - 71 mm	8 knockouts for pipes ø 20 mm in side walls, 1 knockout in the box bottom, spacing for mounting fittings - 60 mm (C), axis distance for drilling holes for the box - 71 mm, 2 screws for mounting fittings are included
Accessories	interconnector KD12, extension rings PD60x12; PD60x24; PD60x30, cover PL60, signalling cover PS60, screws W16; W25; W40	interconnector KD12, extension rings PD60x12; PD60x24; PD60x30, cover PL60, signalling cover PS60, screws W16; W25; W40
Standard	PN-EN IEC 60670-1	PN-EN IEC 60670-1
Collective packaging		





PP

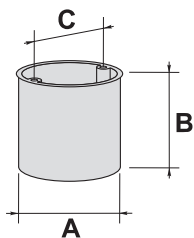

	S60D	S60Dw
		
	deep, serial 60 mm	deep, serial with screws 60 mm
Colour Cat. No.	Blue ● 34 057 203	34 069 203
External dimensions		
A / B / C [mm]	65 / 61 / 60	65 / 61 / 60
Weight	26,7 g	28 g
Material properties	self-extinguishing, halogen-free, resistance to heat 850 °C	self-extinguishing, halogen-free, resistance to heat 850 °C
Additional features	14 knockouts for pipes ø 20 mm in side walls, 1 knockout for pipe ø 18 mm in the bottom, spacing for mounting fittings - 60 mm (C), axis distance for drilling holes for the box - 71 mm	14 knockouts for pipes ø 20 mm in side walls, 1 knockout for pipe ø 18 mm in the bottom, spacing for mounting fittings - 60 mm (C), axis distance for drilling holes for the box - 71 mm, 2 screws for mounting fittings are included
Accessories	signalling cover PS60, protective cover WS60; PL60; interconnector KD12, extension rings PD60x12; PD60x24, screws W16; W25; W40	signalling cover PS60, protective cover WS60; PL60; interconnector KD12, extension rings PD60x12; PD60x24, screws W16; W25; W40
Standard	PN-EN IEC 60670-1	PN-EN IEC 60670-1
Collective packaging		

PP



	S60DF	S60DFw
		
	deep, serial 60 mm	deep, serial with screws 60 mm
Colour Cat. No.	Orange ● 33 057 008	33 069 008
External dimensions		
A / B / C [mm]	65 / 61 / 60	65 / 61 / 60
Weight	21 g	22,3 g
Material properties	resistance to heat 650 °C	resistance to heat 650 °C
Additional features	14 knockouts for pipes ø 20 mm in side walls, spacing for mounting fittings - 60 mm (C), axis distance for drilling holes for the box - 71 mm, special structure with additional rectangular knockouts and connectors that improve stiffness	14 knockouts for pipes ø 20 mm in side walls, spacing for mounting fittings - 60 mm (C), axis distance for drilling holes for the box - 71 mm, 2 screws for mounting fittings are included, special structure with additional rectangular knockouts and connectors that improve stiffness
Accessories	interconnector KD12, extension rings PD60x12; PD60x24; PD60x30, cover PL60; signalling cover PS60, screws W16; W25; W40	interconnector KD12, extension rings PD60x12; PD60x24; PD60x30, cover PL60; signalling cover PS60, screws W16; W25; W40
Standard	PN-EN IEC 60670-1	PN-EN IEC 60670-1
Collective packaging		

7.1.1

FLUSH-MOUNTED JUNCTION BOXES

Standard

PP

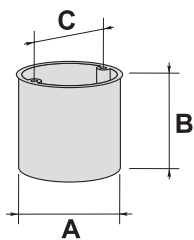

	S60G	S60Gw
		
	extra deep (80 mm) serial 60 mm	extra deep (80 mm) serial with screws 60 mm
Colour Cat. No.		
Blue ●	34 008 203	34 009 203
External dimensions		
A / B / C [mm]	62 / 81 / 60	62 / 81 / 60
Weight	22 g	23 g
Material properties	self-extinguishing, halogen-free, resistance to heat 850 °C	self-extinguishing, halogen-free, resistance to heat 850 °C
Additional features	this box includes special rectangular knockouts and large surfaces for breaking spacing for mounting fittings - 60 mm (C), axis distance for drilling holes for the box - 71 mm	this box includes special rectangular knockouts and large surfaces for breaking spacing for mounting fittings - 60 mm (C), axis distance for drilling holes for the box - 71 mm, 2 screws for drilling holes are included
Accessories	signalling cover PS60, signalling cover W60, PL60; interconnector KD 12, extension rings PD60x12; PD60x24; PD60x30, screws W16; W25; W40	signalling cover PS60, signalling cover W60, PL60; interconnector KD 12, extension rings PD60x12; PD60x24; PD60x30, screws W16; W25; W40
Standard	PN-EN IEC 60670-1	PN-EN IEC 60670-1
Collective packaging		

PP

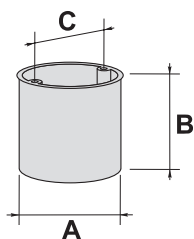

	S60GF	S60GFw	ZV60GFw
			
	extra deep (80 mm) serial 60 mm	extra deep (80 mm) serial with screws 60 mm	extra deep (80 mm) combined with screws 60 mm
Colour Cat. No.			
Orange ●	33 008 008	33 009 008	33 335 008
External dimensions			
A / B / C [mm]	62 / 81 / 60	62 / 81 / 60	68 / 81 / 60
Weight	22 g	23 g	26 g
Material properties	resistance to heat 650 °C	resistance to heat 650 °C	resistance to heat 650 °C
Additional features	this box includes special rectangular knockouts and large surfaces for breaking spacing for mounting fittings - 60 mm (C), axis distance for drilling holes for the box - 71 mm	this box includes special rectangular knockouts and large surfaces for breaking spacing for mounting fittings - 60 mm (C), axis distance for drilling holes for the box - 71 mm, 2 screws for mounting fittings are included	extra deep box 80 mm, with screws for serial connection with KG71 connector, wider surface for mounting fixtures with claws, wider flange with markers for precise marking of drilling axis routing location, marker for drill bit
Accessories	signalling cover PS60, protective cover WS60, PL60; interconnector KD12, extension rings PD60x12; PD60x24; PD60x30, screws W16; W25; W40	signalling cover PS60, protective cover WS60, PL60; interconnector KD12, extension rings PD60x12; PD60x24; PD60x30, screws W16; W25; W40	connector KG71, cover WS60/PL60 extension rings PD60x12; PD60x24; PD60x30, screws W16; W25; W40
Standard	PN-EN IEC 60670-1	PN-EN IEC 60670-1	PN-EN IEC 60670-1
Collective packaging			

PP

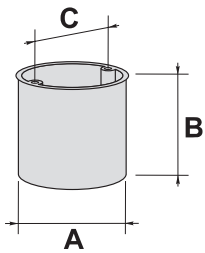

	Z70K	Z80K
	with cover 70 mm	with cover 80 mm
Colour Cat. No.	Blue ● 34 036 203	34 073 203
External dimensions		
A / B / C [mm]	78 / 48,5 / 70	88 / 48,5 / 80
Weight	32 g	37 g
Material properties	self-extinguishing, halogen-free, resistance to heat 850 °C	self-extinguishing, halogen-free, resistance to heat 850 °C
Additional features	6 knockouts for pipes ø 20 mm in side walls 2 knockouts for pipes ø 20 mm in the bottom axis distance for drilling holes for the box - 81 mm protective cover is included	6 knockouts for pipes ø 20 mm in side walls 2 knockouts for pipes ø 20 mm in the bottom axis distance for drilling holes for the box - 92 mm protective cover is included
Accessories	signalling cover E121	
Standard	PN-EN IEC 60670-1	PN-EN IEC 60670-1
Collective packaging		

PP

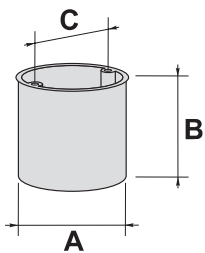

	Z70KF	Z80KF
	with cover 70 mm	with cover 80 mm
Colour Cat. No.	Orange ● 33 036 008	33 073 008
External dimensions		
A / B / C [mm]	78 / 48,5 / 70	88 / 48,5 / 80
Weight	32 g	37 g
Material properties	resistance to heat 650 °C	resistance to heat 650 °C
Additional features	6 knockouts for pipes ø 20 mm in side walls, 2 knockouts for pipes ø 20 mm in the bottom, axis distance for drilling holes for the box - 81 mm, protective cover is included	6 knockouts for pipes ø 20 mm in side walls, 1 knockout for pipes ø 20 mm in the bottom, axis distance for drilling holes for the box - 92 mm, 2 screws for mounting fittings are included
Accessories	signalling cover E121	
Standard	PN-EN IEC 60670-1	PN-EN IEC 60670-1
Collective packaging		





7.1.2

FLUSH-MOUNTED JUNCTION BOXES Multiwall multi-pole

Multiwall®





PP

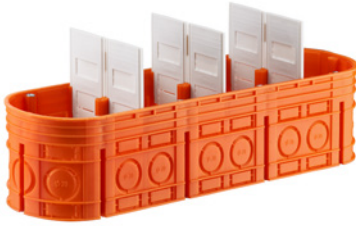

	M2x60F	M3x60F
		
	2-pole 2x60 mm	3-pole 3x60 mm
Colour Cat. No.	Orange ● 33 160 008	33 167 008
External dimensions		
A / B / C [mm]	71 / 63 / 141	71 / 63 / 213
Weight	55 g	85 g
Material properties	resistance to heat 650 °C	resistance to heat 650 °C
Additional features	spacing for mounting fittings - 60 mm, this box is equipped with 2 removable half-partitions with knockout in the lower part for routing the conductors and 4 screws	spacing for mounting fittings - 60 mm, this box is equipped with 4 removable half-partitions with knockout in the lower part for routing the conductors and 6 screws
Accessories	<p>PM1 closing cover (indented for closing outermost – external poles of the box – in the case of using it for installing fittings with enlarged installation space). The cover is placed on the level of upper box flange – due to that fact it does not protrude above the mounted box.</p> <p>PM2 closing cover (intended for closing the central part of the box, in a set with two PM1 covers the entire space of the box can be closed).</p> <p>PS1 and PS2 signalling cover (two outermost PS1 covers or/and central PS2 cover close the space of the box for performance of plaster works).</p> <p>Extension rings PDM60Z, PDM60W are designed to deepen the multi-pole boxes of Multiwall and Multibox2 series. They are mounted with the use of screws directly to the box body. Extension rings can be shortened by cutting the ribs spaced every 6mm. Similarly like in the case of boxes, the rings can be closed with PM1 and PM2 covers. Moreover, PS1 and PS2 signalling covers can be used during plaster works.</p> <p>Screws W16; W25; W40</p>	
Standard	PN-EN IEC 60670-1	PN-EN IEC 60670-1
Collective packaging		

PP



	M4x60F	M5x60F
		
	4-pole 4x60 mm	5-pole 5x60 mm
Colour Cat. No.	Orange ● 33 170 008	33 172 008
External dimensions		
A / B / C [mm]	71 / 63 / 284	71 / 63 / 354
Weight	115 g	148 g
Material properties	resistance to heat 650 °C	resistance to heat 650 °C
Additional features	spacing for mounting fittings – 60 mm, this box is equipped with 6 removable half-partitions with knockout in the lower part for routing the conductors and 8 screws; the side walls are provided with a number of hidden recesses for the connection of cables or tubes ø 20 mm	spacing for mounting fittings – 60 mm, this box is equipped with 8 removable half-partitions with knockout in the lower part for routing the conductors and 10 screws; the side walls are provided with a number of hidden recesses for the connection of cables or tubes ø 20 mm
Accessories	<p>PM1 closing cover (indented for closing outermost – external poles of the box – in the case of using it for installing fittings with enlarged installation space). The cover is placed on the level of upper box flange – due to that fact it does not protrude above the mounted box.</p> <p>PM2 closing cover (intended for closing the central part of the box, in a set with two PM1 covers the entire space of the box can be closed).</p> <p>PS1 and PS2 signalling cover (two outermost PS1 covers or/and central PS2 cover close the space of the box for performance of plaster works).</p> <p>Extension rings PDM60Z, PDM60W are designed to deepen the multi-pole boxes of Multiwall and Multibox2 series. They are mounted with the use of screws directly to the box body. Extension rings can be shortened by cutting the ribs spaced every 6mm. Similarly like in the case of boxes, the rings can be closed with PM1 and PM2 covers. Moreover, PS1 and PS2 signalling covers can be used during plaster works.</p> <p>Screws W16; W25; W40</p>	
Standard	PN-EN IEC 60670-1	PN-EN IEC 60670-1
Collective packaging		

PP



	M6x60F	M6x60FP
	6-pole with a divider 6x60 mm	with cover, without a divider 6x60 mm
Colour Cat. No.		
Orange	33 310 008	33 312 008
External dimensions		
A / B / C [mm]	152 / 50 / 210	152 / 50 / 210 (without cover) 171 / 51,6 / 229 (with cover)
Weight	205 g	186 g
Material properties	resistance to heat 650 °C	resistance to heat 650 °C
Additional features	Flush mounted junction box of Multiwall series with 6 poles for mounting electrotechnical fittings. Installation of the fittings is carried out with the use of two 3-pole frames with a 71 mm standard module. Most types of frames are suitable for spacing between the poles.	Large flush mounted box for placement of electrical and electronic elements. This box is equipped with a cover mounted using 4 acid-resistant screws.
Accessories	<p>PM1 closing cover (indented for closing outermost - external poles of the box - in the case of using it for installing fittings with enlarged installation space). The cover is placed on the level of upper box flange - due to that fact it does not protrude above the mounted box.</p> <p>PM2 closing cover- intended for closing the central part of the box, in a set with two PM1 covers the entire space of the box can be closed.</p> <p>Extension rings PDM60Z, PDM60W are designed to deepen the multi-pole boxes of Multiwall and Multibox2 series. They are mounted with the use of screws directly to the box body. Extension rings can be shortened by cutting the ribs spaced every 6mm. In case of using rings, the surface of the box can be closed with PM1 and PM2 covers, as well as using PS1 and PS2 signalling covers.</p> <p>Screws W16; W25; W40 - alternative for attaching fittings to the box. W16 for additional mounting of fittings with 4 screws. W25 and W40 - if the box is set deeper to fix the fittings.</p>	
Standard	PN-EN IEC 60670-1	PN-EN IEC 60670-1
Collective packaging		

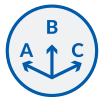

M2x60F
140,8 / 63 / 71

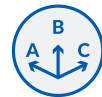
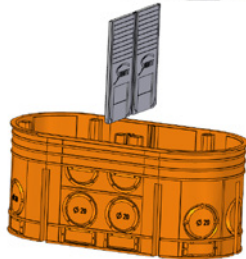
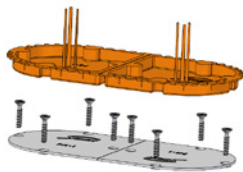

M3x60F
213 / 63 / 71

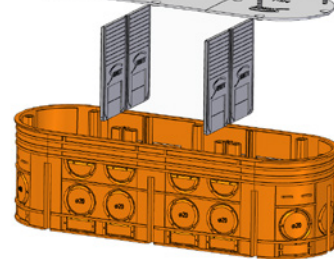
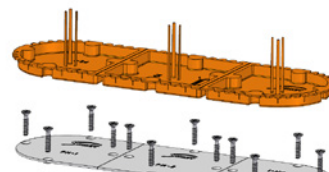

M4x60F
284 / 63 / 71

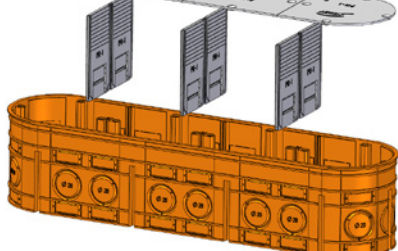
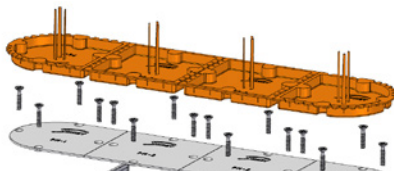

M5x60F
354 / 63 / 71

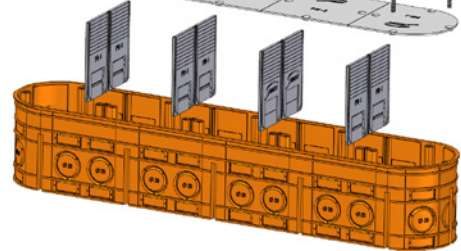
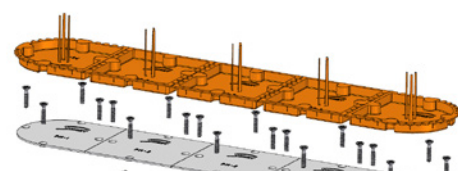

Example of Multiwall M3x60F installation in a wall.

1. Determine the horizontal level and central points with the use of marking openings in the bottom of the junction box.



2. Make the openings with the use of a hole saw min. \varnothing 74 mm.



3. Level out the space using a chisel and adapt it to the shape of the junction box.



4. Verify compatibility of the opening with the junction box. Place the junction box in a wall.







5. Perform the plastering.

Multiwall^{SLIM}®





PP



	M2x60DF	M3x60DF
		
	2-pole 2x60 mm	3-pole 3x60 mm
Colour Cat. No.	Orange ● 33 401 008	33 407 008
External dimensions		
A / B / C [mm]	71 / 63 / 141	71 / 63 / 212
Weight	59 g	93 g
Material properties	resistance to heat 650 °C	resistance to heat 650 °C
Additional features	Hole spacing for mounting fittings 60 mm. Mounting hole 2 x 68 mm, hole spacing 11 mm, 4 fixing screws included.	Hole spacing for mounting fittings 60 mm. Mounting hole 3 x 68 mm, hole spacing 11 mm, 6 fixing screws included.
Accessories	Closing cover PM1, PM2 Connecting cover PKS60 Signalling cover PS3, PS4 Spacer ring PDM60Z, PDM60W, PD60x30 Screws W16, W25, W40	Closing cover PM1, PM2 Connecting cover PKS60 Signalling cover PS3, PS4 Spacer ring PDM60Z, PDM60W, PD60x30 Screws W16, W25, W40
Standard	PN-E 93208; PN-EN IEC 60670-1	PN-E 93208; PN-EN IEC 60670-1
Collective packaging		

PP



	M4x60DF	M5x60DF
		
	4-pole 4x60 mm	5-pole 5x60 mm
Colour Cat. No.	Orange ● 33 414 008	33 416 008
External dimensions		
A / B / C [mm]	71 / 63 / 283	71 / 63 / 354
Weight	125 g	151 g
Material properties	resistance to heat 650 °C	resistance to heat 650 °C
Additional features	Hole spacing for mounting fittings 60 mm. Mounting hole 4 x 68 mm, hole spacing 11 mm, 8 fixing screws included.	Hole spacing for mounting fittings 60 mm. Mounting hole 5 x 68 mm, hole spacing 11 mm, 10 fixing screws included.
Accessories	Closing cover PM1, PM2 Connecting cover PKS60 Signalling cover PS3, PS4 Spacer ring PDM60Z, PDM60W, PD60x30 Screws W16, W25, W40	Closing cover PM1, PM2 Connecting cover PKS60 Signalling cover PS3, PS4 Spacer ring PDM60Z, PDM60W, PD60x30 Screws W16, W25, W40
Standard	PN-E 93208; PN-EN IEC 60670-1	PN-E 93208; PN-EN IEC 60670-1
Collective packaging		

7.1.4

FLUSH-MOUNTED JUNCTION BOXES

for electronics



NEW!

SE2x60D

SE2x60G



montage video



	deep, serial for electronics 2x60 mm	extra deep, serial for electronics 2x60 mm
Colour Cat. No.		
Blue ●	34 117 203	34 159 203
Weight	55,9 g	63 g
Material properties	self-extinguishing, halogen-free, resistance to heat 960 °C	self-extinguishing, halogen-free, resistance to heat 960 °C
Additional features	rectangular knockouts in the bottom and in the walls for the flat wires	Rectangular knockouts in the bottom and in the walls for the flat wires
Accessories	spacer ring PD60x12; PD60x24; PD60x30, interconnector KD12; box cover PL60, WS60, signalling cover PS60, screws W16; W25; W40	spacer ring PD60x12; PD60x24; PD60x30, interconnector KD12; box cover PL60, WS60, signalling cover PS60, screws W16; W25; W40
Standard	PN-EN IEC 60670-1	PN-EN IEC 60670-1
Collective packaging		

SE2x60 and SE2x60G boxes are adapted for mounting specialised electric and electronic devices. Its specially widened interior makes it possible to place extra elements next to the built-up box flange of a steering element. There is also a possibility to use the entire interior of a box for putting various types of devices in it. In such case, the box is closed with a PL60 cover from the top. The box has a serial structure that provides the possibility of combining it into multiple blocks. It is made of two separate elements that are put together using latches. This enables the possibility to mount larger spacious elements inside the box.

7.1.5

FLUSH-MOUNTED JUNCTION BOXES

for wall lights

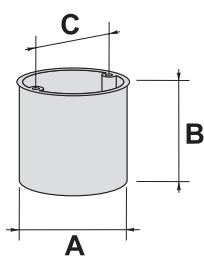





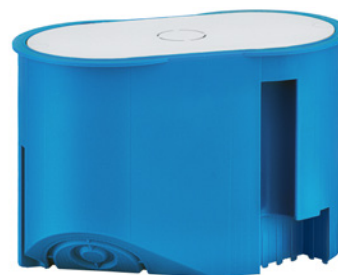

Z32

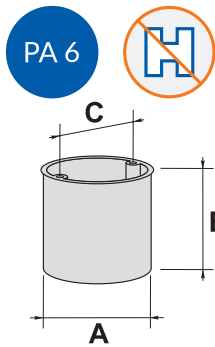
Z2x32



	for wall lights with cover 32 mm	for wall lights with cover 2x32 mm
Colour Cat. No.		
Blue ●	34 010 203	34 011 203
External dimensions		
A / B / C [mm]	38 / 44 / 32	38 / 44 / 68
Weight	10 g	16 g
Material properties	self-extinguishing, halogen-free, resistance to heat 960 °C	self-extinguishing, halogen-free, resistance to heat 960 °C
Additional features	boxes adapted to the use of current branching in the walls and installation of electronic sensors, 1 knockout for pipe ø 20 mm, cover is included with the box	boxes adapted to the use of current branching in the walls and installation of electronic sensors, 2 knockouts for pipe ø 20 mm, cover is included with the box
Standard	PN-EN IEC 60670-1	PN-EN IEC 60670-1
Collective packaging		



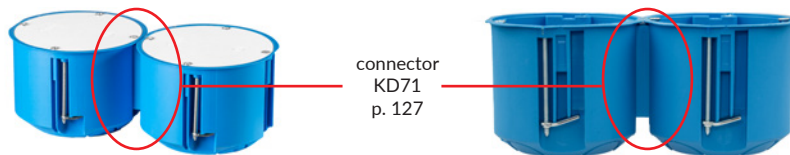

	PV60K	PV60D	PV60G
			NEW! 
	shallow, combined 60 mm	deep, combined 60 mm	extra deep, combined 80 mm
Colour Cat. No.	Blue ● 32 017 203	32 013 203	32 334 203
External dimensions			
A / B / C [mm]	68 / 38,5 / 60	68 / 58,5 / 60	68 / 81 / 60
Weight	25,7 g	34,7 g	41,5 g
Material properties	self-extinguishing, halogen-free, resistance to heat 960 °C	self-extinguishing, halogen-free, resistance to heat 960 °C	self-extinguishing, halogen-free, resistance to heat 960 °C
Additional features	spacing for mounting fittings - 60 mm (C), axis distance for drilling holes for the box - 71 mm, 2 knockouts for pipes ø 20 mm in side walls, 4 knockouts for pipes ø 10 mm in the bottom, 2 screws for mounting fittings are included	spacing for mounting fittings - 60 mm (C), axis distance for drilling holes for the box - 71 mm, 5 knockouts for pipes ø 20 mm, 4 knockouts for pipes ø 10 mm in the bottom, 2 screws for mounting fittings are included	extra deep box 80 mm, with screws for serial connection with KG71 connector, wider surface for mounting fixtures with claws, wider flange with markers for precise marking of drilling axis routing location, marker for drill bit + 2 screws for mounting fittings are included
Accessories	cover PL60 (mounted inside - does not protrude above the box flange), connector KD71, spacer ring PD60x12, PD60x24, PD60x30, cover WS60, screws W16, W25, W40	cover PL60 (mounted inside - does not protrude above the box flange), connector KD71, spacer ring PD60x12, PD60x24, PD60x30, cover WS60, screws W16, W25, W40	connector KG71, cover WS60/PL60 extension rings PD60x12, PD60x24, PD60x30, screws W16, W25, W40
Standard	PN-EN IEC 60670-1	PN-EN IEC 60670-1	PN-EN IEC 60670-1
Collective packaging			

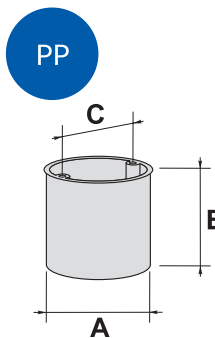

connector
KD71
p. 127



	P60KF	P60DF
		
	shallow 60 mm	deep 60 mm
Colour Cat. No.	Orange ● 31 040 008	31 074 008
External dimensions		
A / B / C [mm]	68 / 45,5 / 60	68 / 58,5 / 60
Weight	22,9 g	27,5 g
Material properties	self-extinguishing, resistance to heat 850 °C	self-extinguishing, resistance to heat 850 °C
Additional features	spacing for mounting fittings - 60 mm (C), axis distance for drilling holes for the box - 71 mm, 4 knockouts for pipes ø 20 mm, 2 knockouts for pipes ø 10 mm, in side walls, 2 knockouts for pipes ø 16 mm in the bottom, 2 screws for mounting fittings are included	spacing for mounting fittings - 60 mm (C), axis distance for drilling holes for the box - 71 mm, 4 knockouts for pipes ø 20 mm, 2 knockouts for pipes ø 10 mm, in side walls, 2 knockouts for pipes ø 16 mm in the bottom, 2 screws for mounting fittings are included
Accessories	spacer ring PD60x12, PD60x24, PD60x30, cover closing WS60, PL60	spacer ring PD60x12, PD60x24, PD60x30, cover closing WS60, PL60
Standard	PN-EN IEC 60670-1	PN-EN IEC 60670-1
Collective packaging		

7.2.1

JUNCTION BOXES FOR CAVITY WALLS

Standard



PA 6

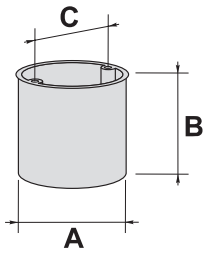

	PV70	PV80
	combined, with cover 70 mm	combined, with cover 80 mm
Colour Cat. No.		
Blue ●	32 150 203	32 087 203
External dimensions		
A / B / C [mm]	74 / 60 / 70	83 / 60 / 80
Weight	46,5 g	52,5 g
Material properties	self-extinguishing, halogen-free, resistance to heat 960 °C, acid-resistant screws	self-extinguishing, halogen-free, resistance to heat 960 °C, acid-resistant screws
Additional features	This box is equipped with a cover screwed using 4 acid-resistant screws. PV70 is an innovative universal solution that allows for a wide range of application. It can be used to mount fittings in it. It can be used to create installation branches, and as a place to fix various electronic elements. A tightly screwed cover, entering into the box, is included. As an option, it is possible to buy a connector that allows to create multiple blocks of boxes. A single frame of a standard electrotechnical fittings hides the box flange. In the case of connecting boxes with the use of KD71 connector, it is not possible to use multiple frames due to different spacing of axes of the connected boxes.	4 knockouts for pipes ø 20. Protective cover screwed with 4 acid-resistant screws is included. Screwed cover enters inside the box at the level of upper flange. Spacing for mounting fittings – 80 mm (C). This box allows for connecting it in sets using connector KD71. Connectors provide the possibility of obtaining box sets for installations e.g. for complex control systems in smart buildings.
Accessories	KD71 - PV series connector	KD71 - PV series connector
Standard	PN-EN IEC 60670-1	PN-EN IEC 60670-1
Collective packaging		

PP

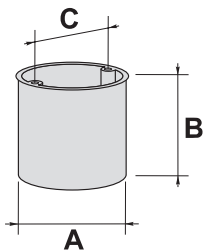

	P70F	P80F
	with cover 70 mm	with cover 80 mm
Colour Cat. No.		
Orange ●	33 242 008	33 244 008
External dimensions		
A / B / C [mm]	74 / 50 / 70	83 / 50 / 80
Weight	36,8 g	39,8 g
Material properties	self-extinguishing, resistance to heat 850 °C, acid-resistant screws	self-extinguishing, resistance to heat 850 °C, acid-resistant screws
Additional features	4 knockouts for pipes ø 20 mm, 2 knockouts for pipes ø 16 mm, spacing for mounting cover 70 mm, protective cover screwed with 4 acid-resistant screws is included box includes two special knockouts for routing conductors between two neighbouring boxes using a pipe ø 16 mm	2 knockouts for pipes ø 20 mm, spacing for mounting fittings - 75 mm (C), protective cover screwed with 4 acid-resistant screws is included, box includes two special knockouts for routing conductors between two neighbouring boxes using a pipe ø 16 mm
Standard	PN-EN IEC 60670-1	PN-EN IEC 60670-1
Collective packaging		



PA 6



with cover **120x45x120 mm**

Colour Cat. No.	
Blue ●	32 042 203
External dimensions	
A / B / C [mm]	105 / 50 / 105 without cover 120 / 45 / 120 with cover
Weight	91 g
Material properties	self-extinguishing, halogen-free, resistance to heat 960 °C, acid-resistant screws
Additional features	8 knockouts for pipes ø 20 mm, 8 knockouts for pipes ø 10 mm, protective cover is included
Standard	PN-EN IEC 60670-1
Collective packaging	

7.2.2

JUNCTION BOXES FOR CAVITY WALLS

Multibox K multi-pole



MULTIBOX® K



P2x60K



P3x60K



shallow, 2-pole **2x60 mm**

shallow, 3-pole **3x60 mm**

Colour Cat. No.	Blue ●	32 322 203	32 324 203
External dimensions	A / B / C [mm]	139 / 45 / 68	210 / 45 / 68
Weight		58,3 g	95,6 g
Material properties		self-extinguishing, halogen-free, resistance to heat 960 °C	self-extinguishing, halogen-free, resistance to heat 960 °C
Accessories		PM1; PM2; PKS60, PDM60x30Z; PDM60x30W, W16; W25; W40	PM1; PM2; PKS60, PDM60x30Z; PDM60x30W, W16; W25; W40
Standard		PN-EN IEC 60670-1	PN-EN IEC 60670-1
Collective packaging			



P4x60K



P5x60K



shallow, 4-pole **4x60 mm**

shallow, 5-pole **5x60 mm**

Colour Cat. No.	Blue ●	32 326 203	32 328 203
External dimensions	A / B / C [mm]	281 / 45 / 68	352 / 45 / 68
Weight		124,6 g	146,9 g
Material properties		self-extinguishing, halogen-free, resistance to heat 960 °C	self-extinguishing, halogen-free, resistance to heat 960 °C
Accessories		PM1; PM2; PKS60, PDM60x30Z; PDM60x30W, W16; W25; W40	PM1; PM2; PKS60, PDM60x30Z; PDM60x30W, W16; W25; W40
Standard		PN-EN IEC 60670-1	PN-EN IEC 60670-1
Collective packaging			

MULTIBOX® 2



	P2x60D	P3x60D
		
	deep, 2-pole 2x60 mm	deep, 3-pole 3x60 mm
Colour Cat. No.		
Blue ●	32 092 203	32 104 203
External dimensions		
A / B / C [mm]	140 / 63 / 68	210 / 63 / 68
Weight	80 g	129 g
Material properties	self-extinguishing, halogen-free, resistance to heat 960 °C, galvanized screws	self-extinguishing, halogen-free, resistance to heat 960 °C, galvanized screws
Additional features	6 knockouts for pipes ø 20 mm, 2 knockouts for pipes ø 16 mm, 4 screws for fittings are included, spacing for mounting fittings - 60 mm, axis distance for drilling holes for the box - 71 mm	8 knockouts for pipes ø 20 mm, 6 knockouts for pipes ø 16 mm, 6 screws for fittings are included, spacing for mounting fittings - 60 mm, axis distance for drilling holes for the box - 142 mm
Accessories	PM1; PKS60	PM1; PM2; PKS60
Standard	PN-EN IEC 60670-1	PN-EN IEC 60670-1
Collective packaging		



	P4x60D	P5x60D
		
	deep, 4-pole 4x60 mm	deep, 5-pole 5x60 mm
Colour Cat. No.		
Blue ●	32 097 203	32 099 203
External dimensions		
A / B / C [mm]	281 / 63 / 68	352 / 63 / 68
Weight	170 g	183,6 g
Material properties	self-extinguishing, halogen-free, resistance to heat 960 °C, galvanized screws	self-extinguishing, halogen-free, resistance to heat 960 °C, galvanized screws
Additional features	10 knockouts for pipes ø 20 mm, 8 knockouts for pipes ø 16 mm, 8 screws for fittings are included, spacing for mounting fittings - 60 mm, axis distance for drilling holes for the box - 213 mm	12 knockouts for pipes ø 20 mm, 12 knockouts for pipes ø 16 mm, 10 screws for fittings are included, spacing for mounting fittings - 60 mm, axis distance for drilling holes for the box - 284 mm
Accessories	PM1; PM2; PKS60	PM1; PM2; PKS60
Standard	PN-EN IEC 60670-1	PN-EN IEC 60670-1
Collective packaging		

7.2.2

JUNCTION BOXES FOR CAVITY WALLS

Multibox 2 multi-pole



MULTIBOX[®] 2



montage video

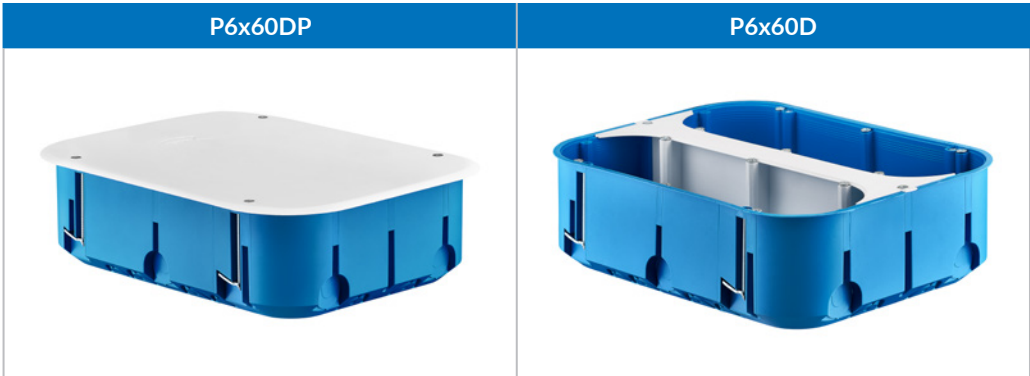

	deep with cover 6x60 mm	deep, 6-pole 6x60 mm
Colour Cat. No.		
Blue ●	32 178 203	32 174 203
External dimensions		
A / B / C [mm]	157 / 63 / 215 230 / 63 / 171 with cover	215 / 63 / 157
Weight	234,8 g	214 g
Material properties	self-extinguishing, halogen-free, resistance to heat 960 °C	self-extinguishing, halogen-free, resistance to heat 960 °C
Additional features	18 knockouts for pipes ø 20 mm, 4 knockouts for pipes ø 16 mm, cover mounted with the use of 4 acid-resistant screws is included, 4 plasterboard hooks	18 knockouts for pipes ø 20 mm, 4 knockouts for pipes ø 16 mm, 12 screws for fittings are included, 4 plasterboard hooks, built-in partition
Accessories	screws for fittings W16; W25; W40	PM1; PM2; PKS 60; screws for fittings W16; W25; W40
Standard	PN-EN IEC 60670-1	PN-EN IEC 60670-1
Collective packaging		

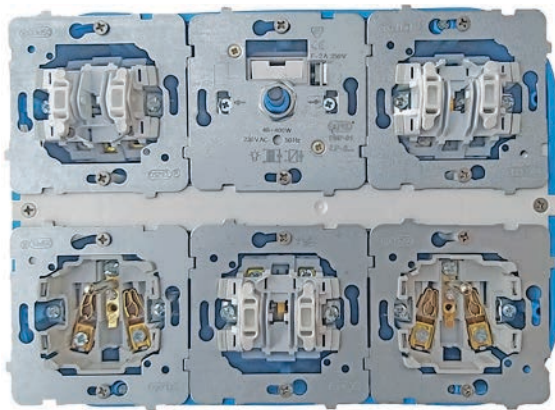

- Structure of the box enables the use of two triple frames of the most major manufacturers (among others: Simon, Ospel).

- The frames are mounted one below the other (horizontally) or one beside the other (vertically).

- Possibility of using the following elements in one body of the box (for example): IT sockets, TV sockets, speaker sockets, antenna sockets, electric sockets, controllers or dimmers.

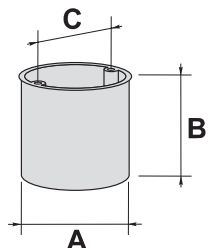

	E2700	E3700
		
	shallow, windproof with membranes 60 mm	deep, windproof with membranes 60 mm
Colour Cat. No.		
Orange ●	83 191 088	83 192 088
External dimensions		
A / B / C [mm]	68 / 47 / 60	68 / 61 / 60
Weight	23 g	27 g
Material properties	self-extinguishing, resistance to heat 850 °C	self-extinguishing, resistance to heat 850 °C
Additional features	2 screws for mounting fittings are included, box for the frame module 71 mm, 4 cable grommets: 2xM25; 2x(3x1,5mm ²); 2x(3x2,5mm ²)-5x1,5mm ²	2 screws for mounting fittings are included, box for the frame module 71 mm, 4 cable grommets: 2xM25; 2x(3x1,5mm ²); 2x(3x2,5mm ²)-5x1,5mm ² , additionally 2 cable grommets for 7x1,5mm ² or 5x2,5mm ²
Accessories	signalling cover PL60, connector E105	signalling cover PL60, connector E105
Standard	EN 60670-1; EN 60670-22	EN 60670-1; EN 60670-22
Collective packaging		





	E5000
	for electronics with membranes 60 mm
Colour Cat. No.	
Orange ●	83 199 008
External dimensions	
A / B / C [mm]	68 / 70 / 60
Weight	43 g
Material properties	self-extinguishing, resistance to heat 850 °C
Additional features	Pocket box (shoe-shaped) intended for mounting electrical components. Flexible structure of the box side allows it to be introduced into \varnothing 68 mm hole from the front of the wall. This box is equipped with membranes \varnothing 25 mm.
Accessories	signalling cover PL60, spacer ring PD60x30, screws W16; W25; W40
Standard	EN 60670-1 (VDE 0606-1); DIN 49073
Collective packaging	

7.2.4

JUNCTION BOXES FOR CAVITY WALLS

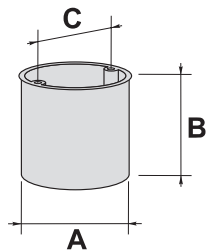
for wall



	P32	P2x32
		
	for wall lights 32 mm	for wall lights 2x32 mm
Colour Cat. No.		
Blue ●	32 020 203	32 023 203
External dimensions		
A / B / C [mm]	38 / 44 / 32	38 / 44 / 68
Weight	12 g	18 g
Material properties	self-extinguishing, halogen-free, resistance to heat 960 °C	self-extinguishing, halogen-free, resistance to heat 960 °C
Additional features	1 knockout for pipes ø 20 mm, cover flush with the box is included	2 knockouts for pipes ø 20 mm, cover flush with the box is included
Standard	PN-EN IEC 60670-1	PN-EN IEC 60670-1
Collective packaging		

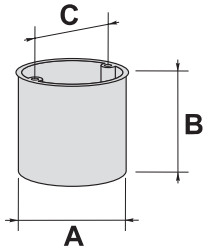

	BS2700	BS3700
		
soundproof, windproof, fire prevention		
Colour Cat. No.		
Black ●	86 161 007	86 163 007
External dimensions		
A / B / C [mm]	68 / 50 / 68	68 / 62 / 68
Fire resistance class	EI120 without insulation wool EI30 - EI60	EI120 without insulation wool EI30 - EI60
Weight	46,5 g	53 g
Additional features	2 holes for M25 tubes	2 holes for M25 tubes
	When the critical temperature is reached, the box reacts and forms an insulating layer. The inside of the box is closed from the inside out in a specific way. The box remains dimensionally stable according to the fire resistance class.	
Standard	DIN EN 60670-1; EN 60670-22	DIN EN 60670-1; EN 60670-22
Collective packaging		

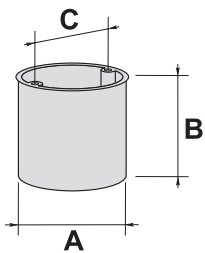





	BS2000	BS3500
		
soundproof, windproof, fire prevention		
Colour Cat. No.		
Black ●	86 160 007	86 162 007
External dimensions		
A / B / C [mm]	68 / 50 / 60	68 / 62 / 68
Fire resistance class	EI120 without insulation wool EI30 - EI60	EI120 without insulation wool EI30 - EI60
Weight	45,5 g	52,5 g
Additional features	4 holes for M20 tubes	4 holes for M20 tubes
	When the critical temperature is reached, the box reacts and forms an insulating layer. The inside of the box is closed from the inside out in a specific way. The box remains dimensionally stable according to the fire resistance class.	
Standard	DIN EN 60670-1 (VDE 0606-1); DIN 49073; DIN EN 60695-2-10 (VDE 0471-2-10)	DIN EN 60670-1 (VDE 0606-1); DIN 49073; DIN EN 60695-2-10 (VDE 0471-2-10)
Collective packaging		

7.3.1





SURFACE JUNCTION BOXES IP20, IP44 series



	PK3	PK8
		
	branch	branch
Colour Cat. No.		
White ○	83 026 006	83 029 006
External dimensions		
A / B / C [mm]	125 / 35 / 125	190 / 80 / 170
Weight	126 g	305 g
Material properties	resistance to heat 650 °C	resistance to heat 650 °C
Standard	EN 60998-1; EN 60998-2-5	EN 60998-1; EN 60998-2-5
Collective packaging*		





*These products are also sold in pieces.



	PK4	PK5
		
	branch	branch
Colour Cat. No.		
White ○	83 027 006	83 028 006
External dimensions		
A / B / C [mm]	125 / 45 / 125	125 / 70 / 125
Weight	197 g	260 g
Material properties	resistance to heat 650 °C	resistance to heat 650 °C
Additional features	installed glands D-25, in the case of using „trough“ type cable glands IP20	installed glands D-25, in the case of using „trough“ type cable glands IP20
Standard	EN 60998-1; EN 60998-2-5	EN 60998-1; EN 60998-2-5
Collective packaging*		





*These products are also sold in pieces.



	PO75	PO75p
		
	with insert	without insert
Colour Cat. No.		
White ○	83 012 006	83 011 006
External dimensions		
A / B / C [mm]	85 / 40 / 85	85 / 40 / 85
Weight	77 g	57 g
Material properties	resistance to heat 650 °C	resistance to heat 650 °C
Additional features	with clamp insert 4x2,5 mm ²	
Standard	EN 60998-1; EN 60998-2-5	EN 60998-1; EN 60998-2-5
Collective packaging*		

*These products are also sold in pieces.



	PH	PH/p	PK-2P
			
	with insert	without insert	branch
Colour Cat. No.			
White ○	83 014 006	83 013 006	83 023 006
External dimensions			
A / B / C [mm]	85 / 40 / 85	85 / 40 / 85	103 / 60 / 103
Weight	73 g	53 g	151 g
Material properties	resistance to heat 650 °C	resistance to heat 650 °C	resistance to heat 650 °C
Additional features	with clamp insert 4x2,5 mm ² , installed glands D-13,5	installed glands D-13,5	installed glands D-25
Standard	EN 60998-1; EN 60998-2-5	EN 60998-1; EN 60998-2-5	EN 60998-1; EN 60998-2-5
Collective packaging*			

*These products are also sold in pieces.

7.3.2

SURFACE JUNCTION BOXES IP54



NS cutter - p. 132



	NS5	NS6	NS7
	self-latching	self-latching	self-latching
Colour Cat. No.			
Grey ●	35 360 102	35 346 102	35 349 102
Black ●	35 360 107	35 346 107	35 349 107
White ○	35 360 106	35 346 106	35 349 106
Red ●	35 360 101	35 346 101	35 349 101
Brown ●	35 360 115	35 346 115	35 349 115
External dimensions			
A / B / C [mm]	75 / 75 / 40	85 / 85 / 40	100 / 100 / 40
Weight	38,4 g	46,3 g	58,6 g
Material properties	self-extinguishing, resistance to heat 650 °C, halogen-free, UV resistance	self-extinguishing, resistance to heat 650 °C, halogen-free, UV resistance	self-extinguishing, resistance to heat 650 °C, halogen-free, UV resistance
Additional features	can be mounted with HNS hooks	can be mounted with HNS hooks	can be mounted with HNS hooks
Accessories	NS cutter, hook HNS	NS cutter, hook HNS	NS cutter, hook HNS
Standard	PN-EN IEC 60670-1	PN-EN IEC 60670-1	PN-EN IEC 60670-1
Collective packaging			



NS cutter - p. 132



	NS8	NS9	HNS
	self-latching	self-latching	hook
Colour Cat. No.			
Grey ●	35 357 102	35 404 102	37 345 202
Black ●	35 357 107	35 404 107	37 345 207 (on request)
White ○	35 357 106	35 404 106	37 345 206 (on request)
Red ●	35 357 101	35 404 101	37 345 201 (on request)
Brown ●	35 357 115	35 357 115	37 345 115 (on request)
External dimensions			
A / B / C [mm]	45 / 40 / 85	90 / 40 / 135	7,8 / 43,8 / 41,7
Weight	28,9 g	79,9 g	2,8 g
Material properties	self-extinguishing, resistance to heat 650 °C, halogen-free, UV resistance	self-extinguishing, resistance to heat 650 °C, halogen-free, UV resistance	self-extinguishing, resistance to heat 650 °C, halogen-free, UV resistance, RAL7004
Additional features	cannot be mounted with HNS hooks	can be mounted with HNS hooks	-
Accessories	NS cutter, hook HNS	NS cutter, hook HNS	-
Standard	PN-EN IEC 60670-1	PN-EN IEC 60670-1	PN-EN IEC 60670-1
Collective packaging			



METHOD OF INSTALLATION

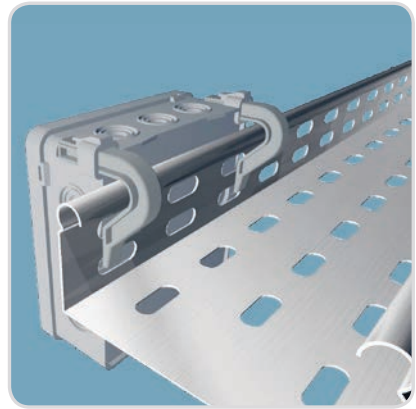
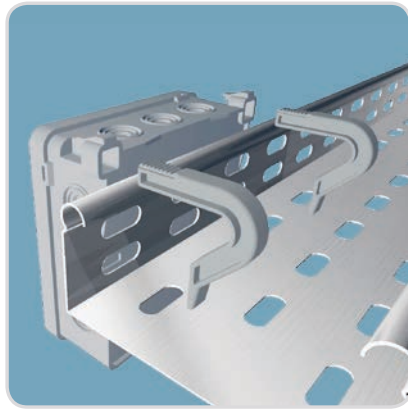
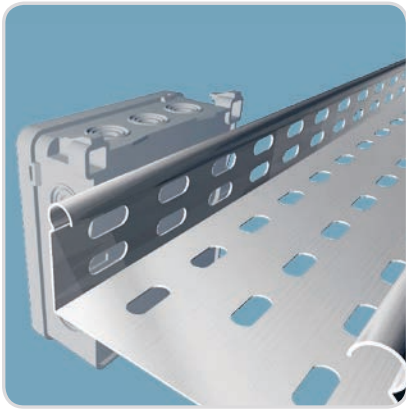

FEATURES

QUICK INSTALLATION

Installation with the HNS hook on the cable route yeses less than 10 seconds.



NEW SOLUTIONS

Innovative method of mounting with hooks registered at the patent office.



MOUNTING BRACKET

Mounting bracket with cable ties or Ø 6mm screws for easy installation.



STIFF COVER

The self-locking cover is made of polypropylene. Its smooth surface allows for placement of the description of the installation.



LATERAL KNOCKPUT

One central knockout in box NS8.



COLOUR

Boxes available in 5 colours: white, grey, brown, black and red.



Montage video



FASTBOX®
& HOOK



7.3.3

SURFACE JUNCTION BOXES IP54



N80x80F



PE

N90x90F



PE

	N80x80F	N90x90F
Colour Cat. No.		
Grey ●	35 210 002	35 220 002
External dimensions		
A / B / C [mm]	88 / 58 / 88	98 / 60 / 98
Weight	64,8 g	83,3 g
Material properties	self-extinguishing, resistance to heat 650 °C, RAL 7035, RAL 7012 on request	self-extinguishing, resistance to heat 650 °C, RAL 7035, RAL 7012 on request
Additional features	7 knockouts for cable glands, 4 knockouts in the cover allowing for its tightening using screws W16, can be sealed, glands integrated in the body	7 knockouts for cable glands, 4 knockouts in the cover allowing for its tightening using screws W16, can be sealed, glands integrated in the body
Accessories	branched terminal blocks: ZPT 4x2.5; ZPT 5x2.5; ZPT 4x4.0; ZPT 5x4.0	branched terminal blocks: ZPT 4x2.5; ZPT 5x2.5; ZPT 4x4.0; ZPT 5x4.0; ZPT 5x10
Standard	PN-EN IEC 60670-1	PN-EN IEC 60670-1
Collective packaging		

NEW!

NPP100

NPP130



PE
body

PP
cover



self-latching

self-latching

	NPP100	NPP130
Colour Cat. No.		
White ○	35 380 006	35 390 006
Grey ●	35 380 002	35 390 002
External dimensions		
A / B / C [mm]	100 / 52 / 100	130 / 53 / 130
Weight	64,3 g	101,5 g
Material properties	resistance to heat 650 °C, UV resistant	resistance to heat 650 °C, UV resistant
Additional features	8 knockouts for cable gland, 4 cable glands	8 knockouts for cable gland, 8 cable glands
Accessories	Cable gland DM3G (grey) or DM2W (white)	Cable gland DM3G (grey) or DM2W (white)
Standard	PN-EN IEC 60670-1	PN-EN IEC 60670-1
Collective packaging		



NEW!

NSW90x90

DMW1



PS



TPE

with 1 screw

cable glands



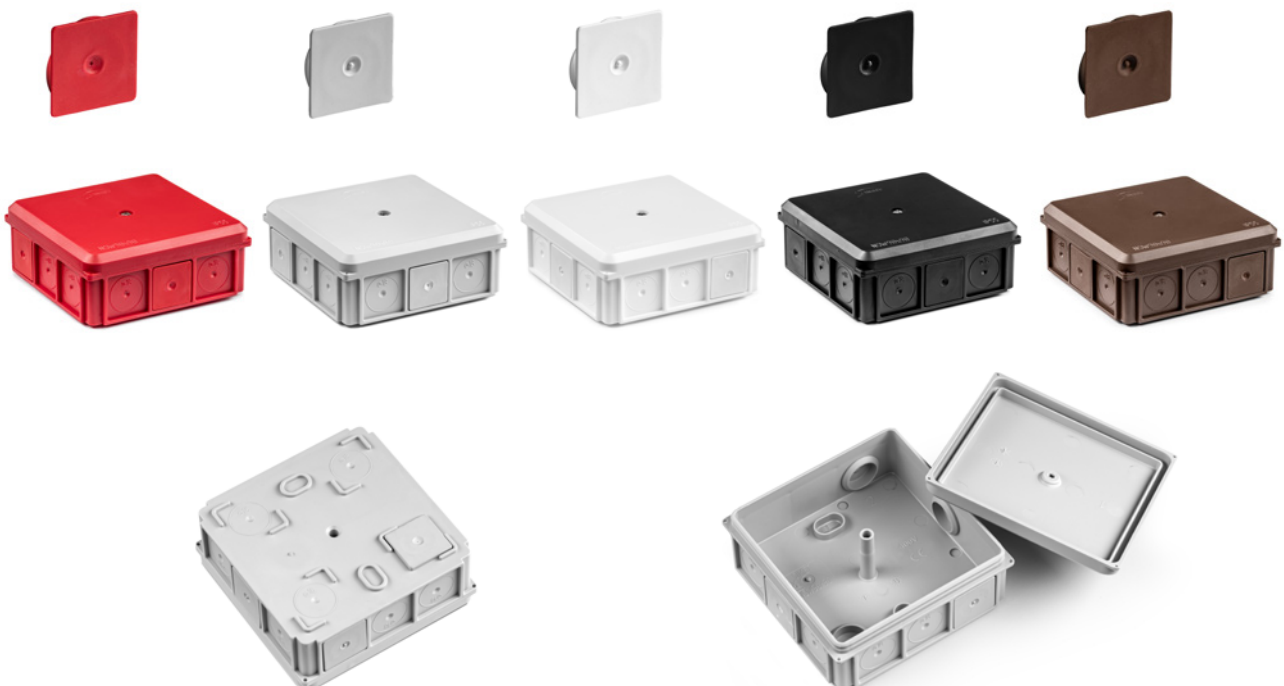



	with 1 screw	cable glands
Colour Cat. No.		
White ○	37 418 706	37 421 906
Grey ●	37 418 702	37 421 902
Black ●	37 418 707	37 421 907
Brown ●	37 418 715	37 421 915
Red ●	37 418 701	37 421 901
External dimensions		
A / B / C [mm]	90 / 37 / 90	8 / 23 / 23
Weight	64 g	1,2 g
Material properties	resistance to heat 650 °C	-
Accessories	5 cable glands DMW1 are included	-
Additional features	<ul style="list-style-type: none"> 16 knockouts ø 18mm for cable glands cable feed-in from the bottom of the box the box can be sealed from 4 sides 2 sockets for fixing dowels, stainless steel screw 	-
Standard	PN-EN IEC 60670-1, PN-EN 60670-22	PN-EN IEC 60670-1, PN-EN 60670-22
Collective packaging		



7.3.4
7.3.5

SURFACE JUNCTION BOXES, OBUDOWY HERMETYCZNE
IP55, IP67



	N80x80	N90x90	N110x110
	 PA 6	 PA 6	 PA 6
	88x55x88 mm	98x60x98 mm	118x68x118 mm
Colour Cat. No.			
White ○	35 110 206	35 120 206	35 130 206
External dimensions			
A / B / C [mm]	88 / 55 / 88	98 / 60 / 98	118 / 68 / 118
Weight	105,1 g	130,4 g	164,2 g
Material properties	self-extinguishing, halogen-free, UV resistant, resistance to heat 960 °C	self-extinguishing, halogen-free, UV resistant, resistance to heat 960 °C	self-extinguishing, halogen-free, UV resistant, resistance to heat 960 °C
Additional features	7 knockouts for cable glands (Ø 28 mm), 3 cable glands included DM1 (13, 16, 20, 25 mm). Cover screwed with 4 acid-resistant screws. Cover with rubber gasket.	7 knockouts for cable glands (Ø 28 mm), 3 cable glands included DM1 (13, 16, 20, 25 mm). Cover screwed with 4 acid-resistant screws. Cover with rubber gasket.	7 knockouts for cable glands (Ø 28 mm), 3 cable glands included, DM1 (13, 16, 20, 25 mm). Cover screwed with 4 acid-resistant screws. Cover with rubber gasket.
Accessories	branched terminal blocks: ZPT 4x2.5; ZPT 5x2.5; ZPT 4x4.0; ZPT 5x4.0, DM1 membrane gland	branched terminal blocks: ZPT 4x2.5; ZPT 5x2.5; ZPT 4x4.0; ZPT 5x4.0; ZPT 4x10; ZPT 5x10, DM1 membrane gland	branched terminal blocks: ZPT 4x2.5; ZPT 5x2.5; ZPT 4x4.0; ZPT 5x4.0; ZPT 4x10; ZPT 5x10, DM1 membrane gland
Standard	PN-EN IEC 60670-1	PN-EN IEC 60670-1	PN-EN IEC 60670-1
Collective packaging			



NEW!



	SOH110x180	SOH180x180
	 PA 6 body PC cover	 PA 6 body PC cover
	air-tight housing	air-tight housing
Colour Cat. No.		
White ○	36 432 206	36 434 206
Grey ●	36 432 202	36 434 202
External dimensions		
A / B / C [mm]	118 / 108 / 188	188 / 108 / 188
Weight	292 g	458 g
Material properties	resistance to heat 850 °C	resistance to heat 850 °C
Additional features	12 knockouts for cable gland, nails PG16(Ø 23 mm) and PG21(Ø 29 mm), 4 acid-resistant screws	12 knockouts for cable gland, nails PG16(Ø 23 mm) and PG21(Ø 29 mm), 4 acid-resistant screws
Standard	PN-EN IEC 60670-1	PN-EN IEC 60670-1
Collective packaging		

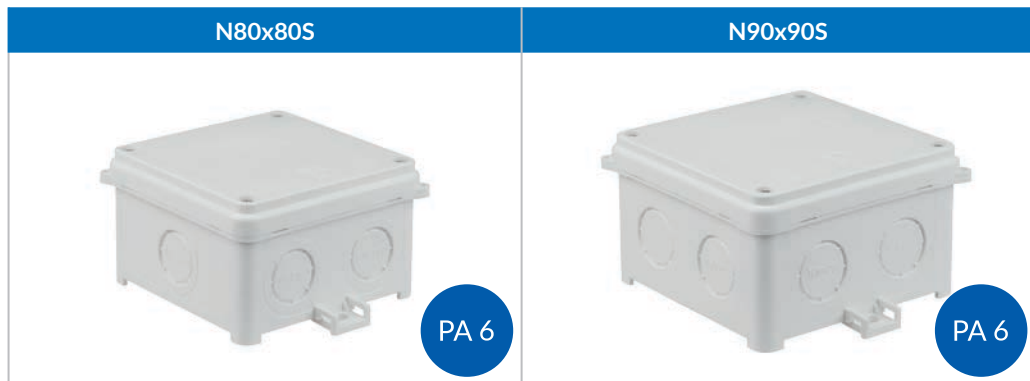

	N80x80S	N90x90S
External dimensions	88x55x88 mm	98x60x98 mm
Colour Cat. No.		
White ○	35 133 206	35 135 206
External dimensions		
A / B / C [mm]	88 / 55 / 88	98 / 60 / 98
Weight	92,6 g	117,6 g
Material properties	self-extinguishing, halogen-free, UV resistant, resistance to heat 960 °C	self-extinguishing, halogen-free, UV resistant, resistance to heat 960 °C
Additional features	The product has 7 knockouts for PG 13.5 (Ø 21 mm) threaded cable glands. <i>Cover screwed with 4 acid-resistant screws.</i>	The product has 7 knockouts for PG 16 (Ø 23 mm) threaded cable glands. <i>Cover screwed with 4 acid-resistant screws.</i>
Accessories	Screwed cable glands PG13,5 or rubber glands DM1	Screwed cable glands PG16 or rubber glands DM1
Standard	PN-EN IEC 60670-1	PN-EN IEC 60670-1
Collective packaging		



	N110x110S	N110x180S	N180x180S
External dimensions	118x68x118 mm	118x68x188 mm	188x88x188 mm
Colour Cat. No.			
White ○	35 137 206	35 270 206	35 300 206
Grey ●	-	35 270 202 NEW	35 300 202 NEW
External dimensions			
A / B / C [mm]	118 / 68 / 118	118 / 68 / 188	188 / 88 / 188
Weight	152,2 g	213,3 g	413 g
Material properties	self-extinguishing, halogen-free, UV resistant, resistance to heat 960 °C	self-extinguishing, halogen-free, UV resistant, resistance to heat 960 °C	self-extinguishing, halogen-free, UV resistant, resistance to heat 960 °C
Additional features	The product has 7 knockouts for cable glands, PG16 (Ø 23 mm) and PG21 (Ø 29 mm) threaded cable glands, <i>4 acid-resistant screws</i>	The product has 12 knockouts for PG16 (Ø 23 mm) and PG21 (Ø 29 mm) threaded cable glands, <i>4 acid-resistant screws</i> ,	The product has 7 knockouts for cable glands, PG16 (Ø 23 mm) and PG21 (Ø 29 mm) threaded cable glands, <i>4 acid-resistant screws</i>
Accessories	PG16 and PG21 screw glands1	PG16 and PG21 screw glands1	PG16 and PG21 screw glands1
Standard	PN-EN IEC 60670-1	PN-EN IEC 60670-1	PN-EN IEC 60670-1
Collective packaging			

7.4

FIRE PROTECTION JUNCTION BOXES



HOW TO READ THE MARKING

PIP-1AN B 3 x 2 x 4 → max. conductor cross-section to
 ↓ number of openings in the connection block
 ↓ block number of ceramic connections blocks
 B(with a fuse), R(branched), P(pass-through)



	PIP-1AN B3x2x4	PIP-1AN R3x2x4
	0,375 A	16 A
Colour Cat. No.	Red ● 84 621 606	84 621 616
Dimensions A / B / C [mm]	115 / 28 / 123 with cable grommets	115 / 28 / 123 with cable grommets
Fire resistance	E90	E90
Weight	255 g	255 g
Material properties	powder coated sheet metal, cable grommets of flame retardant material	powder coated sheet metal, cable grommets of flame retardant material
Additional features	possibility of installing W2 signalling device on the box cover	possibility of installing W2 signalling device on the box cover
Wiring diagram	<p>PIP-1AN with a fuse</p>	<p>PIP-1AN/Branched</p>
Standard	DIN 4102-12	DIN 4102-12
Collective packaging		



	PIP-2AN B2x3x4	PIP-2AN P2x3x4
	0,375 A	32 A
Colour Cat. No.	Red ● 84 622 606	84 622 616
Dimensions A / B / C [mm]	88 / 30 / 166 with cable grommets	103 / 30 / 197 with cable grommets
Fire resistance	E90	E90
Weight	334 g	406 g
Material properties	powder coated sheet metal, cable grommets of flame retardant material	powder coated sheet metal, cable grommets of flame retardant material
Additional features	base enabling the wire entry from the substrate side	
Wiring diagram	<p>PIP-2AN with a fuse</p>	<p>PIP-2AN/Pass-through/6x4mm²</p>
Standard	DIN 4102-12	DIN 4102-12
Collective packaging		



	PIP-2AN P3x3x4	PIP-2AN P3x3x6
	32 A	41 A
Colour Cat. No.	Red ● 84 622 626	84 622 636
Dimensions A / B / C [mm]	103 / 30 / 197 with cable grommets	125 / 36 / 225 with cable grommets
Fire resistance	E90	E90
Weight	434 g	585 g
Material properties	powder coated sheet metal, cable grommets of flame retardant material	powder coated sheet metal, cable grommets of flame retardant material
Wiring diagram	<p>PIP-2AN/Pass-through/9x4mm²</p>	<p>PIP-2AN/Pass-through/9x6mm²</p>
Standard	DIN 4102-12	DIN 4102-12
Collective packaging		



	PIP-2AN R2x3x4	PIP-2AN R3x3x4	PIP-2AN R3x3x6
	16 A	16 A	16 A
Colour Cat. No.	Red ● 84 622 646	84 622 656	84 622 666
Dimensions A / B / C [mm]	103 / 30 / 197 with cable grommets	103 / 30 / 197 with cable grommets	125 / 36 / 225 with cable grommets
Fire resistance	E90	E90	E90
Weight	331 g	457 g	620 g
Material properties	powder coated sheet metal, cable grommets of flame retardant material	powder coated sheet metal, cable grommets of flame retardant material	powder coated sheet metal, cable grommets of flame retardant material
Additional features	base enabling the wire entry from the substrate side		
Wiring diagram	<p>PIP-2AN/Branched/4mm²</p>	<p>PIP-2AN/Branched/3 wires/4mm²</p>	<p>PIP-2AN/Branched/3 wires/6mm²</p>
Standard	DIN 4102-12	DIN 4102-12	DIN 4102-12
Collective packaging			



PIP-3AN B6x2x4



PIP-3AN R6x2x4



0,75 A

16 A

Colour Cat. No.		
Red ●	84 623 606	84 623 616
Dimensions A / B / C [mm]	124 / 28 / 137 with cable grommets	124 / 28 / 137 with cable grommets
Fire resistance	E90	E90
Weight	350 g	355 g
Material properties	powder coated sheet metal, cable grommets of flame retardant material	powder coated sheet metal, cable grommets of flame retardant material
Additional features	possibility of installing W2 signalling device on the box cover	possibility of installing W2 signalling device on the box cover
Wiring diagram	<p>PIP-3AN with a fuse</p>	<p>PIP-3AN/Branched</p>
Standard	DIN 4102-12	DIN 4102-12
Collective packaging		



PIP-5A R4x3x4 , 4x2x4



PIP-7A P10x2x4







dwupoziomowa 16 A

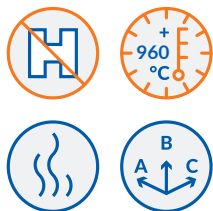



32 A

Colour Cat. No.		
Red ●	84 625 616	84 627 616
Dimensions A / B / C [mm]	92 / 47 / 174 with cable grommets	114 / 30 / 286 with cable grommets
Fire resistance	E90	E90
Weight	739 g	916 g
Material properties	powder coated sheet metal, cable grommets of flame retardant material	powder coated sheet metal, cable grommets of flame retardant material
Additional features	base enabling the wire entry from the substrate side	
Wiring diagram	<p>Wiring diagram 1</p> <p>Wiring diagram 2</p>	
Standard	DIN 4102-12	DIN 4102-12
Collective packaging		

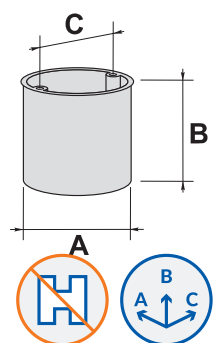

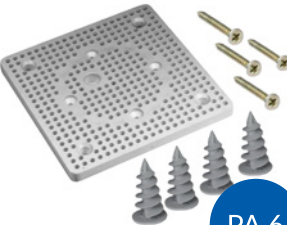
	P1kn71x71	P2kn71x142
		
	PA 6	PA 6
	for fittings 60 mm, on TS 35 rail 71x71 mm	for fittings 2x60 mm, on TS 35 rail 71x142 mm
Colour Cat. No.	White ○ 36 070 206	White ○ 36 071 206
External dimensions		
A / B / C [mm]	71 / 48 / 71	71 / 48 / 142
Weight	58,1 g	85 g
Material properties	self-extinguishing, halogen-free, resistance to heat 960 °C	self-extinguishing, halogen-free, resistance to heat 960 °C
Additional features	4 knockouts for pipes \varnothing 16 mm, 4 knockouts for pipes \varnothing 10...16 mm in side walls, 3 outputs to wires \varnothing 8 mm in the bottom, spacing for mounting fittings 60 mm	2 knockouts for pipes \varnothing 16 mm, 2 outputs to wires \varnothing 8 mm, 4 knockouts for pipes \varnothing 10...16 mm, in side walls, 2 outputs to wires \varnothing 8 mm in the bottom, spacing for mounting fittings 60 mm
Mounting	on TS 35 rail	on TS 35 rail
Standard	PN-EN IEC 60670-1	PN-EN IEC 60670-1
Collective packaging		



	PST60	PMST60	EPS20
			
	PA 6	PA 6	
	for polystyrene 70 mm	mounting plate 110x110 mm	block of polystyrene with a box 60mm
Colour Cat. No.	Blue ● 32 273 003	White ○ 32 277 006	White ○ 83 113 003
External dimensions			
A / B / C [mm]	68 / 46 / 70	110 / 8 / 110	184 / 205 / 184
Weight	24,1 g	105,4 g	560 g
Material properties	self-extinguishing, halogen-free, resistance to heat 960 °C	self-extinguishing, halogen-free, resistance to heat 960 °C	halogen-free, resistance to heat 650 °C
Additional features	PST60 box is a simple method to mount installation sockets or to create branches on existing insulations of the buildings. Just drill a hole in the insulation with \varnothing 68 mm and insert the box. In order to fix the box firmly, you need to push the internal elements of the box outwards with a thumb. In order to improve the box's holding properties, you can cover the sides of the box with a silicone or construction acrylic before mounting. This box can be combined in frame systems with the use of KD71 connector and it can be covered with the use of PL60 cover. Spacing for mounting fittings – 60 mm.	Supporting mounting plate is fixed on a junction box or directly on an insulated wall. It is used for mounting such elements as camera, antenna or sensors that do not exceed 4 kg. It is equipped with 4 special spiral pins made of plastic, along with screws.	The block is fixed during the covering of the wall with an insulation layer, because it must be glued to the surface of the main wall. The block with embedded junction box is 200 mm deep and allows for adjustment of its depth in the range 80-200 mm, depending on the thickness of the insulation. For this purpose, the bottom part of polystyrene is appropriately cut. Fixing to the wall is done by gluing the EPS20 block to the wall surface, preferably with a special adhesive (251-KL) or other construction adhesive. Subsequently, it is enclosed by insulation and creates compact solid structure with the wall. In addition, it includes a pad for fixing elements on the surface of the polystyrene, e.g. cameras, sensors, antennas, etc. Construction adhesive 251-KL, bearing capacity 12 kg.
Standard	PN-EN IEC 60670-1		
Collective packaging			



HAD01



PA 6

HAD02

NEW!



PS

connection to cookers with clamps couplings

connection to cookers with quick-release

Colour Cat. No.		
White ○	35 350 206	35 444 206
External dimensions		
A / B / C [mm]	80 / 25 / 80	22 / 110,2 / 128,2
Weight	92 g	148,2 g
Additional features	The product is equipped with 5 two-hole 6mm ² branch terminal blocks and a clamp for wedging the supply cable. The box can be assembled by means of expansion bolts or screws into Ø 60 mm flush mounting or plaster boxes.	The product is equipped with 5 SCL3 quick-connectors and 4 3.5 x 15 mm screws and 2 cable holders.
Standard	PN-EN IEC 60670-1	PN-EN IEC 60670-1
Collective packaging		
Montage video		



PDD60















PA 6

shallow, for wooden houses **60 mm**

Colour Cat. No.	
Blue ●	32 223 203
External dimensions	
A / B / C [mm]	60 / 58,5 / 60
Weight	50 g
Material properties	self-extinguishing, halogen-free, resistance to heat 960 °C
Additional features	Set includes: a cover with 2 mounting screws, 4 screws for mounting to a board, 2 additional screws for fittings. This junction box is intended for wooden houses. It is mounted in a cavity wall from the inside of it (in the wood panel, plasterboard, etc.)
Accessories	extension ring PD60x30, screws W25; W40
Standard	PN-EN IEC 60670-1
Collective packaging*	

*These Product are also sold in pieces.

	TIGHTENING MEMBRANES		
	E06	E07	E08
			
	ø 16 mm	ø 20 mm	ø 25mm
Colour Cat. No.			
Grey ●	83 206 302	83 207 302	83 208 302
External dimensions			
Outer dia./ inner dia.	16 mm / 11 mm	20 mm / 15 mm	25 mm / 19.5 mm
Additional features	Tightening membrane for pipes, conduits, and junction boxes, Ø external pipes 16 mm, Ø internal pipes 11 mm.	Tightening membrane for pipes, conduits, and junction boxes, Ø external pipes 20 mm, Ø internal pipes 15 mm.	Tightening membrane for pipes, conduits, and junction boxes, Ø external pipes 25 mm, Ø internal pipes 19,5 mm.
	Standard application of cable grommets consists of tightening the pipes inserted into the boxes. If the inserted conduits are loose, then the installation is not airtight. Tightening of the ending of a pipe or conduit inserted into the box makes the connection windproof (particularly in flush mounted installations).		
Collective packaging			

	TIGHTENING MEMBRANES		GROMMET
	E09	E10	DM1
			
	ø 32 mm	ø 40 mm	ø 32 mm
Colour Cat. No.			
Grey ●	83 209 302	83 210 302	_____
White ○	_____	_____	37 113 916
External dimensions			
Outer dia./ inner dia.	32 mm / 25 mm	40 mm / 31,5 mm	32 mm / 28 mm
Additional features	Tightening membrane for pipes, conduits, and junction boxes, Ø external pipes 32 mm, Ø internal pipes 25 mm.	Tightening membrane for pipes, conduits, and junction boxes, Ø external pipes 40 mm, Ø internal pipes 31,5 mm.	Cable grommet for surface boxes with IP55 and 67. It allows for mounting installation pipes or conductors with the following diameters: 10; 13.5; 16; 20; 25 mm. This grommet includes internal flanges that improve tightness of mounted wires.
	Standard application of cable grommets consists of tightening the pipes inserted into the boxes. If the inserted conduits are loose, then the installation is not airtight. Tightening of the ending of a pipe or conduit inserted into the box makes the connection windproof (particularly in flush mounted installations).		
Collective packaging			

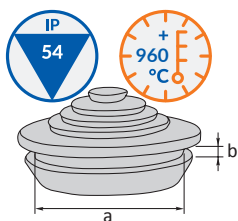

GROMMETS STM25



ø 25 mm

Colour Cat. No.	Grey ● 83 121 002
External dimensions	
Mouning hole dia. / depth	23-26 mm / 3 mm
Diameters after cut-off for pipe embedding	ø 5 ... 16 mm
Additional features	Rubber grommets intended for tightening the inlets of junction boxes for IP 54 protection. A proper diameter is achieved by cutting off a grommet's protruding part with the use of utility knife. The grommet is made of a special flexible rubber that provides a tight connection with the introduced pipe or wire.
Collective packaging	

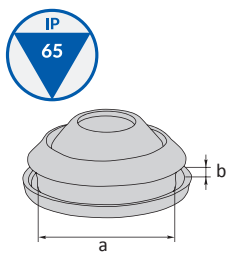

	DMS20	DMS25	DMS32
--	-------	-------	-------



ø 20 mm

ø 25 mm

ø 32 mm

Colour Cat. No.	Grey ● 83 124 002	Grey ● 83 125 002	Grey ● 83 126 002
External dimensions			
Mouning hole dia. / depth	20 mm / 3 mm	25 mm / 3 mm	32 mm / 3 mm
Diameters after cut-off for pipe embedding	ø 7 ... 12 mm	ø 12 ... 18 mm	ø 14 ... 23 mm
Collective packaging			

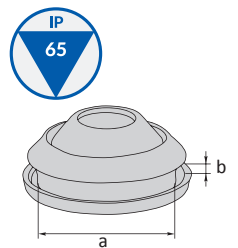















DM2G



TPE



Colour Cat. No.	Grey ● 37 396 902
	White ○ 37 396 906
Weight	1,25 g
External dimensions	
Mouning hole dia. / depth	16 mm / 4 mm
Diameters after cut-off for pipe embedding	ø 6,4 ... 13,7 mm
Collective packaging	

	KD71	KG71	KG71
			
	PA 6	PA 6	PP
	connector	connector	connector
Colour Cat. No.			
Blue ●	37 015 003	37 341 203	-
Orange ●	-	-	37 341 008
External dimensions			
A / B / C [mm]	14 / 42 / 23	19,2 / 77,5 / 28	19,2 / 77,5 / 28
Material properties	self-extinguishing, halogen-free, resistance to heat 960 °C	self-extinguishing, halogen-free, resistance to heat 960 °C	self-extinguishing, halogen-free, resistance to heat 650 °C
Weight	3 g	3 g	3 g
Additional features	For connecting boxes PV60K; PV60D; PST60; PV70; PV80.	For connecting boxes PV60G.	For connecting boxes ZV60GFw.
Collective packaging			





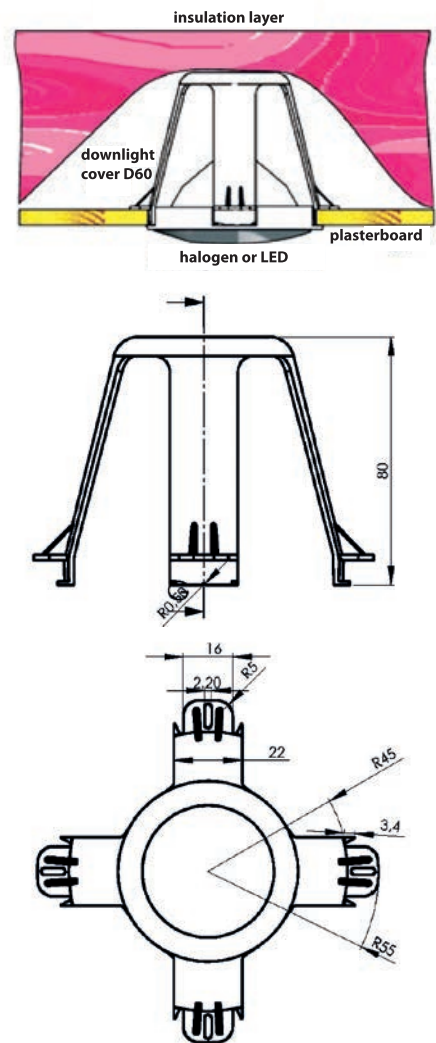

	KZ71	E105	KD12
			
			PA 6
	connector	connector	connector
Colour Cat. No.			
Grey ●	37 261 002	_____	37 088 003
Orange ●	_____	83 129 008	-
External dimensions	A / B / C [mm]	diameter / height [mm]	
	16 / 27 / 28,3	14 / 21,4	22 / 22 / 27,2
Material properties	resistance to heat 650 °C	self-extinguishing, halogen-free, resistance to heat 850 °C	self-extinguishing, halogen-free, resistance to heat 960 °C
Weight	4 g	2 g	2,5 g
Additional features	This connector is intended for a serial connection of boxes: ZZ60KFw, ZZ60DFw. It provides the standard frame spacing of 71 mm, which enables the use of multi-pole frames with any number of poles.	Connector for windproof boxes: E2700; E3700; SP3700.	It increases the spacing of serially connected boxes by 14 mm for the application of single frames (S60K; S60KF; S60Kw; S60KFw; S60D; S60DF; S60DFw; S60G; S60Gw; SE2x60; SE2x60G).
Collective packaging			

7.6.2

EQUIPMENT FOR JUNCTION BOXES downlight cover, fitting screws



DOWNLIGHT COVER D60	
	
	
60-85x80 mm	
Colour Cat. No.	Blue ● 83 300 002
External dimensions	Outer dia./ depth 60-85 mm / 80 mm
Material properties	self-extinguishing, halogen-free, resistance to heat 960 °C
Weight	20 g
Additional features	<p>A specialised downlight cover made of self-extinguishing halogen-free polyamide, which is safe for electrotechnical applications. This product is intended for creating a safe distance between the insulation layer and the source of light in the wall. Fixed LED bulbs and halogen lamps need to dissipate the heat that is generated on the inside of the wall. If there is an insulation layer implemented, it is necessary to "move it away" from the light source for the purpose of fire safety, as well as for the purposes of extending durability of the light source.</p> <p>Mounting:</p> <ul style="list-style-type: none"> Drill the mounting hole with a diameter 60 ... 85 mm Insert the downlight cover into the hole and push it using fingers outwards, so that its teeth get into the sides of the hole. Insert the lighting fixture and embed it traditionally with the use of spring wings between the downlight cover's ribs.
Collective packaging	







	W16	W25	W40
			
	screw 16 mm	screw 25 mm	screw 40 mm
Colour Cat. No.	37 086 160	37 086 250	37 086 400
External dimensions	Length 16 mm	Length 25 mm	Length 40 mm
Collective packaging			







Multiwall®







		SIGNALLING COVERS	
		PS1	PS2
			
		PE	PE
		70x72 mm	70x72 mm
Colour Cat. No.			
Orange ●		37 165 008	37 166 008
External dimensions			
		70 x 72 mm	70 x 72 mm
Material properties		resistance to heat 650 °C	resistance to heat 650 °C
Weight		7 g	8 g
Additional features		Signalling cover for boxes of Multiwall and Multibox series. It covers the outermost pole of the boxes. It is used to mark the location of the box under the plaster.	Signalling cover for boxes of Multiwall and Multibox series. It covers the central pole of the box and along with two PS1 covers, it closes the box in its entirety. It is used to mark the location of the box under the plaster.
Collective packaging			









NEW!
Multiwall Slim®





		SIGNALLING COVERS	
		PS3	PS4
			
		PE	PE
		71,3x71 mm	70,6x71 mm
Colour Cat. No.			
Orange ●		37 409 008	37 410 008
External dimensions			
		71,3 x 71 x 8	70,6 x 71 x 8
Material properties		resistance to heat 650 °C	resistance to heat 650 °C
Weight		7,6 g	9,0 g
Additional features		Signalling cover for boxes of MultiwallSlim series. It covers the outermost pole of the boxes. It is used to mark the location of the box under the plaster.	Signalling cover for boxes of MultiwallSlim series. It covers the central pole of the box and along with two PS3 covers, it closes the box in its entirety. It is used to mark the location of the box under the plaster.
Collective packaging			

		PS60	E121
			
		PE	PA 6
		signalling cover 60 mm	signalling cover 70 mm
Colour Cat. No.			
Red ●			83 188 001
Orange ●		37 083 008	
External dimensions			
External diameter		ø 64 mm	ø 74 mm
Material properties		resistance to heat 650 °C	resistance to heat 650 °C
Weight		4,8 g	6 g
Additional features		Signalling cover for boxes 60 mm (Z, ZZ S and SE series). It is used to mark the location of the box under the plaster.	Signalling cover for boxes 70 mm (Z70K, Z70KF series). It is used to mark the location of the box under the plaster.
Collective packaging			







	PDM60Z	SPACER RING	PDM60W	
				
				
	30x71x71 mm		30x71x71 mm	
Colour Cat. No.				
White ○	37 288 006		37 289 006	
External dimensions	30 x 71 x 71 mm		30 x 71 x 71 mm	
Material properties	self-extinguishing, halogen-free, resistance to heat 960 °C		self-extinguishing, halogen-free, resistance to heat 960 °C	
Weight	20 g		18 g	
Additional features	Spacer ring, segmented, external, mounted with 2 screws W16 for Multiwall and Multibox series.		Spacer ring, segmented, internal, mounted with 2 screws W16 for Multiwall and Multibox series.	
Collective packaging				

	PD60X12	PD60X24	PD60X30
			
			
	60x12 mm	60x24 mm	universal 60x30 mm
Colour Cat. No.			
White ○	37 058 006	37 059 006	37 012 006
External dimensions			
Spacing of fixing holes	60 mm	60 mm	60 mm
Height	12 mm	24 mm	30 mm
Material properties	self-extinguishing, halogen-free, resistance to heat 960 °C		
Weight	6 g	11 g	25 g
Additional features	spacer rings are used to increase depth of boxes Z60K; Z60KF; Z60Kw; Z60KFw; Z60D; Z60F; Z60Dw; SE2x60; SE2x60G; Z60DFw; S60K; S60KF; S60Kw; S60KFw; S60D; S60DF; S60DFw; S60G; S60Gw; PD60x30 - - ring with 5 detachable segments every 6 mm		
Collective packaging			

	ONEGEL	ZP18
		
	filling gel	hook for junction boxes for the cavity walls
Colour Cat. No.		
Transparent ○	89 154 000	37 260 180
Operating temperature	- 60 °C ... +200 °C	_____
Capacity	10 GΩ/mm	_____
Weight	300 ml	_____
Additional features	This is an insulating and filling gel for spaces where electric and electronic devices are located. It insulates from the effects of humidity, water, dust and gas. ADVANTAGES: ready to use, transparent, non-toxic, eco-friendly, easy to use, allows for reusing of the terminal block, for vertical as well as horizontal application.	A hook for junction boxes for the cavity walls Multibox, P6x60D, P60DF, P60KF, PV60K.
Collective packaging		

	WS60	WS70/80
		
	cover 60 mm	cover 70/80 mm
Colour Cat. No.		
White ○	89 001 006	37 081 006
External dimensions		
	∅ 72 mm	∅ 93 mm
Material properties	resistance to heat 650 °C	resistance to heat 650 °C
Weight	5,3 g	11,1 g
Additional features	spring hooks for junction boxes ∅ 60	spring hooks for junction boxes ∅ 70 and ∅ 80
Collective packaging		

	PKS60	PL60
	 PA 6	 PA 6
	cover 60 mm	cover 60 mm
Colour Cat. No.		
White ○	37 268 306	37 107 006
External dimensions		
	71 x 71 mm	∅ 59 mm
Material properties	self-extinguishing, halogen-free, resistance to heat 960 °C	self-extinguishing, halogen-free, resistance to heat 960 °C
Weight	13,8 g	3,3 g
Additional features	This cover allows for inserting the electrical wires into a junction box ∅ 60mm. Special channels allow for inserting the conductor (3-wire 1,5 or 2,5 mm ²). It enables the implementation of connections in a box, as well as the routing of two flexible 3-wire power cables with a diameter up to 2,5 mm ² outside the box to the devices (e.g. induction hob).	Facing cover for PV60K, PV60D, PV60G, SE2x60, SE2x60G plasterboard boxes. It can be used for other boxes (Z... and S... series, however in such case it is mounted on the surface of the box).
Collective packaging		

Multiwall®
Multiwall®
MULTIBOX®

	Cover	
	PM1	PM2
	 PA 6	 PA 6
	66x69 mm	66x71 mm
Colour Cat. No.		
White ○	37 162 006	37 163 006
External dimensions		
	66 x 69 mm	66 x 71 mm
Material properties	self-extinguishing, halogen-free, resistance to heat 960 °C	self-extinguishing, halogen-free, resistance to heat 960 °C
Weight	6 g	7 g
Additional features	Cover closing the outermost poles in boxes of Multiwall and Multibox series. Fixed with 4 fitting screws W16.	Cover closing the central poles in boxes of Multiwall and Multibox series. Along with two PM1 covers, it closes the entire space of the box. Fixed with 4 fitting screws W16.
Collective packaging		

7.6.5

EQUIPMENT FOR JUNCTION BOXES

mounting ring, windproof insert, cutter

FASTRING®

for boxes:

S60KF, S60KFw,
S60DF, S60DFw,
S60GF, S60GFw,
Z60DF, Z60DFw,
S60K, S60Kw,
S60D, S60Dw,
S60G, S60Gw,
Z60D, Z60Dw



PM-85

NEW!



montage video



mounting ring

Colour Cat. No.	Orange ●	37 422 008
Material properties	resistance to heat 650 °C	
Dimensions	external Ø 88mm, internal Ø 62,8 mm	
Weight	6,5 g	
Additional features	Suitable for installation at temperatures below 0 °C, mounting depths 10 mm or 15 mm, stable and solid mounting of the box. Without mortar, assembly of rings on the jointed boxes.	
Collective packaging		

Product designed for use in flush-mounted and cavity wall boxes. The insert provides a windproof seal in 60mm single installation boxes.



WU60

NEW!



montage video



windproof insert for single 60mm boxes

Colour Cat. No.	White ○	37 443 906	Collective packaging
Material properties	resistance to heat 960 °C		
Number of cable entries	8		
Dimensions	70 / 41 / 70 mm		
Weight	10,4 g		
Additional features	Sealing insert for cavity wall boxes, windproof. Compliant with EN IEC 60695-2-11.		

F-CLIP



NS cutter



mounting ring

cutter for knockouts

Colour Cat. No.	White ○	83 187 003	Blue ●	37 400 803
External diameter	max. up to 60 mm of groove or wall chase			
Material properties	resistance to heat 650 °C			
Weight	2 g		5,2 g	
Additional features	A clip for mounting cables in grooves. It replaces problematic initial plastering or limits the hammering of nails.		Cutter for knockouts in surface boxes of FASTBOX&HOOK, FASTBOX series.	
Collective packaging				

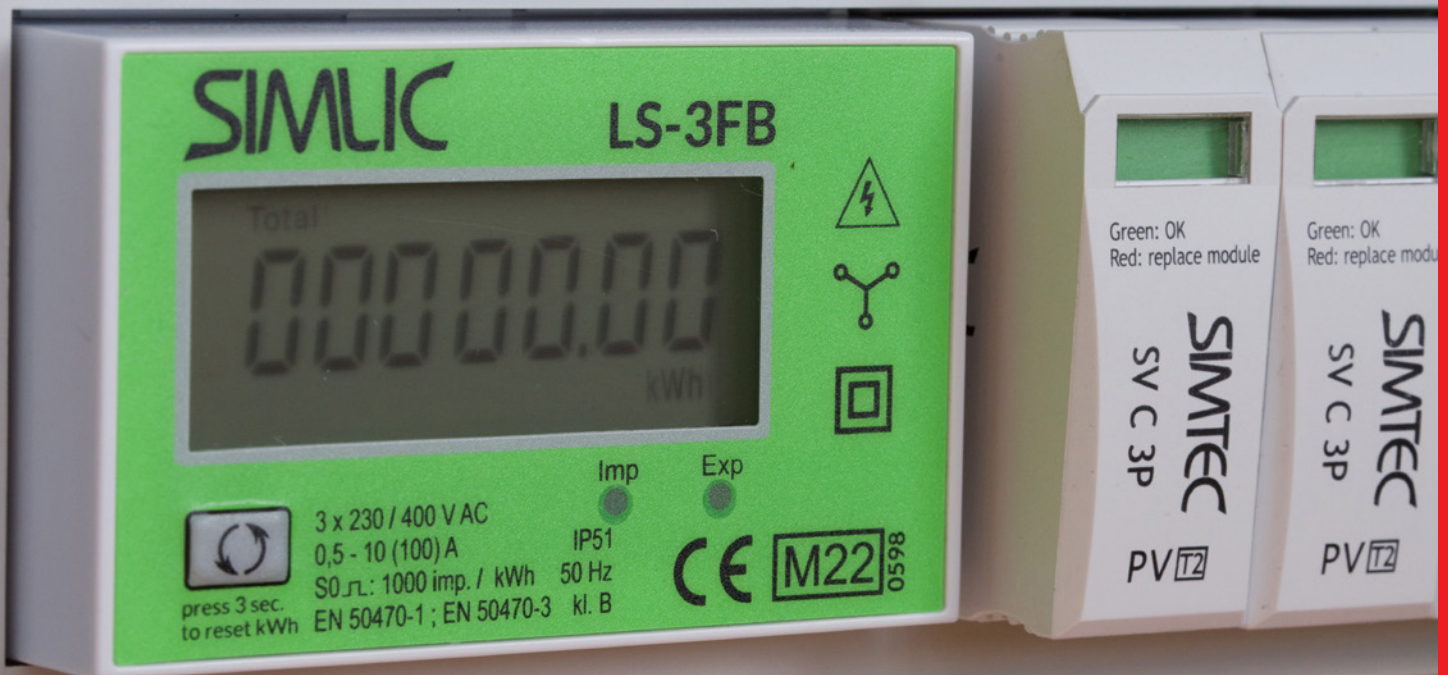

MODULAR APPARATUS

Plan your safety

SIMTEC®

SIMTEC - varistor surge arresters used in electrical installations for the surge protection. They fulfil an important role in the reduction of voltage surges. Their task consists of:

type 2 surge arresters - prevention of voltage surges up to 1-1,5 kV

type 3 surge arresters - direct protection of selected electrical and electronic devices, which are sensitive to any voltage surges, in the single-family and multi-family construction.

Type 3

SM 3D

rated discharge current
8-20 μs (In):
1,5 kA

maximum continuous operating voltage (Uc):
255 V

examples of application:
For

junction boxes

Cat. no. 85 303 000
Compliance with standards:
IEC 61643-11.

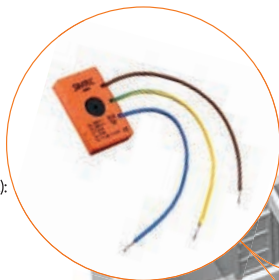

Type 1+2

ST 30B+C 4P

rated discharge current
8-20 μs (In):
30 kA

maximum continuous operating voltage (Uc):
275 V

pulse current limp (10/350 μs):
4,5 kA

examples of application:
protection of

detached houses, apartments

Cat. no. 85 201 010
Compliance with standards:
IEC 61643-11.



Type 3

SM10D 1P

rated discharge current
8-20 μs (In):
10 kA

maximum continuous operating voltage (Uc):
275 V

examples of application:
protection of rooms, groups of devices

Cat. no. 85 301 000
Compliance with standards:
IEC 61643-11

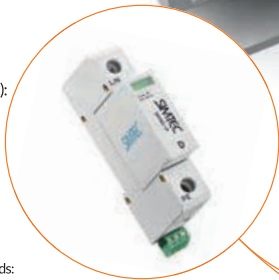

Type 2

SM 20C 4P

rated discharge current
8-20 μs (In):
20 kA

maximum continuous operating voltage (Uc):
275 V

examples of application:

protection of detached houses, apartments

Cat. no. 85 102 000
Compliance with standards:
IEC 61643-11



13

Years on the Polish market

We sell in Poland and in European countries:



Best value for money







Safety
Controlled
Production
Simtec
www.tuv.com
ID1419044582

Varistor surge arresters hold the TÜV Rheinland certificate. They undergo quality control - directly in the production process. This constitutes an additional guarantee of reliability, which in the case of products intended for protection determines the safety of people and devices.

Electrical parameters

	SM20C 1P grey	SM20C 4P grey
		
	T2	T2
Colour Cat. No.		
	85 101 000	85 102 000
Rated voltage AC (U _n)	230 V	230 V
Rated discharge current (I _n 8/20 μs)	20 kA	20 kA
Max. continuous operating voltage (U _c)	275 V	275 V
Max. discharge current (I _{max} 8/20 μs)	40 kA	40 kA
Voltage protection level (U _p)	≤ 1,2 kV	≤ 1,2 kV
Actuation time (t _a)	≤ 25 ns	≤ 25 ns
Permissible humidity (R _h)	≤ 95 %	≤ 95 %
Insulation resistance (R _{iso})	> 10 ⁹ MΩ	> 10 ⁹ MΩ
Max. additional fuse (gL/gG)	125 A	125 A
Frequency (f)	40 ... 63 Hz	40 ... 63 Hz
Remote signalling of damage / contact / carrying capacity	Yes / switchable potential-free / AC 250 V / 0,5 A	Yes / switchable potential-free / AC 250 V / 0,5 A
Standard	EN 61643-11	EN 61643-11

Mechanical parameters

Nominal cross-section of connected wires		
- stiff	2,5 ... 35 mm ²	2,5 ... 35 mm ²
- flexible	2,5 ... 25 mm ²	2,5 ... 25 mm ²
Housing material	PA 6	PA 6
Pad status indicator	optical: green / red	optical: green / red
Mounting	on TS 35 rail	on TS 35 rail
Operating temperature range (T _o)	-40 °C... +85 °C	-40 °C ... +85 °C
IP rating	IP20	IP20
Thermal disconnecter	yes	yes
Wire cross-section of remote signalling	max 1,5 mm ² wire, stranded wire	max 1,5 mm ² wire, stranded wire

Collective packaging		
----------------------	---	---

SPDMM20C-275 grey

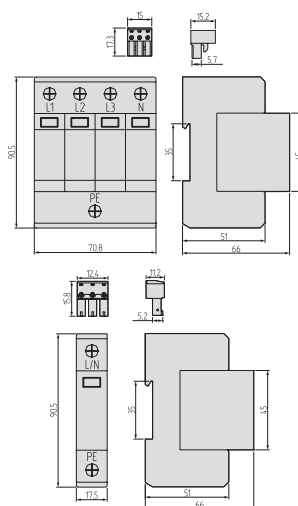

	T2
Colour Cat. No.	85 101 012
Application	varistor protective module for Simtec surge arresters of C class (for SM20C 1P grey and SM20C 4P grey)
Collective packaging	



Safety
Controlled
Production

Simtec

www.tuv.com
ID1419047553

Varistor surge arresters hold the TÜV Rheinland certificate. They undergo quality control - directly in the production process. This constitutes an additional guarantee of reliability, which in the case of products intended for protection determines the safety of people and devices.

Electrical parameters

	ST30B+C 1P grey	ST30B+C 4P grey
	T1 T2	T1 T2
Colour Cat. No.		
	85 202 010	85 201 010
Rated voltage AC (U_n)	230 V	230 V
Rated discharge current (I_n 8/20 μ s)	30 kA	30 kA
Max. continuous operating voltage (U_c)	275 V	275 V
Impulse current (I_{imp} 10/350 μ s)	4,5 kA	4,5 kA
Max. discharge current (I_{max} 8/20 μ s)	60 kA	60 kA
Voltage protection level (U_p)	$\leq 1,5$ kV	$\leq 1,5$ kV
Actuation time (t_a)	≤ 25 ns	≤ 25 ns
Permissible humidity (R_h)	≤ 95 %	≤ 95 %
Insulation resistance (R_{iso})	$> 10^9$ M Ω	$> 10^9$ M Ω
Max. additional fuse (gL/gG)	125 A	125 A
Frequency (f)	40 ... 63 Hz	40 ... 63 Hz
Remote signalling of damage / contact / carrying capacity	Yes / switchable potential-free / AC 250 V / 0,5 A	Yes / switchable potential-free / AC 250 V / 0,5 A
Standard	EN 61643-11	EN 61643-11

Mechanical parameters

Nominal cross-section of connected wires		
- stiff	2,5 ... 35 mm ²	2,5 ... 35 mm ²
- flexible	2,5 ... 25 mm ²	2,5 ... 25 mm ²
Housing material	PBT	PBT
Pad status indicator	optical: green / red	optical: green / red
Mounting	on TS 35 rail	on TS 35 rail
Operating temperature range (T_o)	-40 °C ... +85 °C	-40 °C ... +85 °C
IP rating	IP20	IP20
Thermal disconnecter	yes	yes
Wire cross-section of remote signalling	max 1,5 mm ² wire, stranded wire	max 1,5 mm ² wire, stranded wire

Collective packaging		
----------------------	--	--

STDMM30B+C-275 orange



	STDMM30B+C-275 orange
	T1 T2
Colour Cat. No.	
	85 201 028
Application	varistor protective module for Simtec surge arresters of C class (for SM30B+C 1P grey and SM30B+C 4P grey)
Collective packaging	

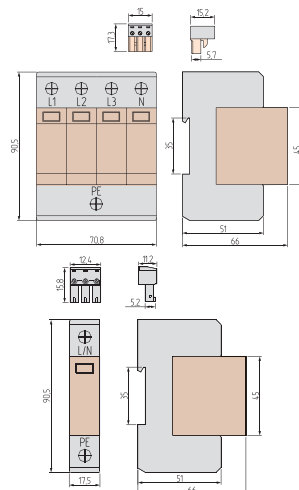

SM10D 1P grey



Electrical parameters

	T3
Colour Cat. No.	85 301 000
Rated voltage AC (U_n)	275 V
Rated discharge current (I_n 8/20 μ s)	10 kA
Max. continuous operating voltage (U_c)	275 V
Max. discharge current (I_{max} 8/20 μ s)	20 kA
Voltage protection level (U_p)	≤ 1 kV
Actuation time (t_a)	≤ 25 ns
Permissible humidity (R_h)	$\leq 95\%$
Insulation resistance (R_{iso})	$> 10^9$ M Ω
Max. additional fuse (gL/gG)	80 A
Frequency (f)	40 ... 63 Hz
Remote signalling of damage / contact / carrying capacity	Yes / switchable potential-free / AC 230 V / 0,5 A
Standard	PN-EN 61643-11; CE Declaration of Conformity

Mechanical parameters

Nominal cross-section of connected wires	
- stiff	2,5 ... 35 mm ²
- flexible	2,5 ... 25 mm ²
Housing material	PA 6
Pad status indicator	optic
Mounting	on TS 35 rail
Operating temperature range (T_U)	-40 °C ... +85 °C
IP rating	IP20
Thermal disconnecter	yes
Wire cross-section of remote signalling	max 1,5 mm ² wire, stranded wire

Collective packaging

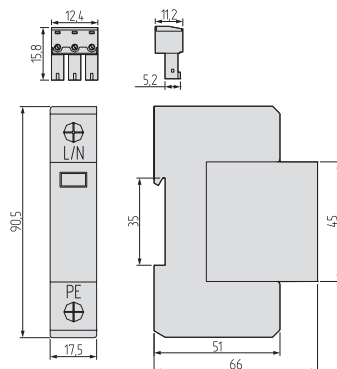

SIMTEC®

SM3D Orange

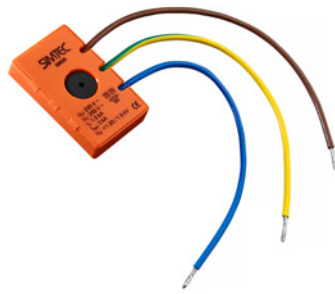

Electrical parameters

	T3
Colour Cat. No.	85 303 000
Rated voltage AC (U_n)	230 V
Rated discharge current (I_n , 8/20 μ s)	1,5 kA
Max. continuous operating voltage (U_c)	255 V
Max. discharge current (I_{max})	3 kA
Voltage protection level	$\leq 1,5$ kV
Actuation time (t_a)	≤ 25 ns
Permissible humidity (R_h)	$\leq 95\%$
Insulation resistance (R_{iso})	$> 10^9$ M Ω
Max. additional fuse (gL/gG)	32 A
Frequency (f)	40 ... 63 Hz
Remote signalling of damage / contact / carrying capacity	sound signalling
Standard	EN 61643-11
Mechanical parameters	
Cross - connected wires	
- stiff	2,5 ... 35 mm ²
- flexible	2,5 ... 25 mm ²
Housing material	PBT
Pad status indicator	acoustic
Mounting	in a box
Operating temperature range (T_U)	-40 °C ... +85 °C
IP rating	IP20
Thermal disconnecter	yes
Collective packaging	

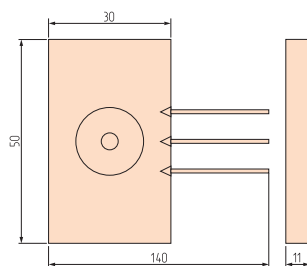

Tested for lightning strike resistance according to EN 61643-11 by:



Two-stage surge arresters type 1 and type 2 are used to limit potentials in power supply installations due to atmospheric over voltages and to protect against internal over voltages in the power supply network. Mainly used in LV installations in facilities such as residential, office and public buildings. They are installed in cable joints or main distribution boards.

Electrical parameters

	T1 T2
Colour Cat. No.	85 205 003
System rated voltage AC (U_n)	230 V
Impulse current (I_{imp} 10/350 μ s)	12,5 kA
Total impulse current 10/350 μ s ($I_{imp total}$)	50 kA
Rated discharge current (I_n 8/20 μ s)	30 kA
Max. discharge current (I_{max} 8/20 μ s)	60 kA
Voltage protection level (U_p)	$\leq 1,5$ kV
Actuation time (t_d)	< 25 ns
Permissible humidity (R_h)	≤ 95 %
Insulation resistance (R_{iso})	> 10^9 M Ω
Max. additional fuse (gL/gG)	125 A
Frequency (f)	40 Hz ... 63 Hz
Remote signalling of damage / contact / carrying capacity	Yes / switchable potential-free / AC 250 V / 0,5 A
Standard	EN 61643-11

Mechanical parameters

Nominal cross-section of connected wires	
- stiff	2,5 ... 35 mm ²
- flexible	2,5 ... 25 mm ²
Housing material	PA 6
Status indicator	optical: green (ok) / red (damaged)
Mounting	on TS 35 rail
Operating temperature range	-40 °C.. +85 °C
IP rating	IP20
Connecting fork rail	modular spacing 18 mm
Thermal disconnecter	yes
Wire cross-section of remote signalling	max 1,5 mm ² (wire, stranded wire)

Collective packaging	
----------------------	--



SIMTEC®

PV

SV B+C 3P



Type Approved
Safety
Regular Production
Surveillance

www.tuv.com
ID 1111263680

SV C 3P



Type Approved
Safety
Regular Production
Surveillance

www.tuv.com
ID 1111263678

Electrical parameters

	T1 T2	T2
Colour Cat. No.		
	85 036 002	85 034 002
Rated voltage of photovoltaic system DC (U_{npv})	1000 V	1000 V
Max. continuous operating voltage photovoltaic system DC (U_{cpv})	1060 V	1060 V
Impulse current ($I_{imp,10/350\mu s}$)	6,25 kA	-
Rated discharge current ($I_n, 8/20\mu s$)	20 kA	20 kA
Max. discharge current ($I_{max, 8/20\mu s}$)	40 kA	40 kA
Voltage protection level (U_p)	$\leq 4,5$ kV	$\leq 4,5$ kV
Actuation time (t_A)	< 25 ns	< 25 ns
Permissible humidity (R_h)	≤ 95 %	≤ 95 %
Insulation resistance (R_{iso})	$> 10^9$ M Ω	$> 10^9$ M Ω
Max. additional fuse (gL/gG)	100 A	100 A
Remote signalling of damage / contact / carrying capacity	Yes / switchable potential-free / AC 250 V / 0,5 A	Yes / switchable potential-free / AC 250 V / 0,5 A
Standard	EN 61643-31	EN 61643-31

Mechanical parameters







Nominal cross-section of connected wires		
- stiff	2,5 ... 35 mm ²	2,5 ... 35 mm ²
- flexible	2,5 ... 25 mm ²	2,5 ... 25 mm ²
Housing material	PA 6	PA 6
Status indicator	optical: green (ok) / red (damaged)	optical: green (ok) / red (damaged)
Mounting	on TS 35 rail	on TS 35 rail
Operating temperature range	-40 °C ... +85 °C	-40 °C ... +85 °C
IP rating	IP20	IP20
Connecting fork rail	modular spacing 18 mm	modular spacing 18 mm
Thermal disconnecter	yes	yes
Wire cross-section of remote signalling	max 1,5 mm ² (wire, stranded wire)	max 1,5 mm ² (wire, stranded wire)

Collective packaging



SIMLIC®



	LS-1F	LS-3F	LS-3FB
			
	single-phase meter	three-phase meter	three-phase two-way meter
Colour Cat. No.			
	85 401 010	85 402 010	85 403 010
Rated voltage AC (U_n)	230 V	3 x 230 V / 400 V	3 x 230 V / 400 V
Impulse rated voltage (U_{imp})	6 kV	6 kV	6 kV
Minimum current (I_{min})	0,25 A	0,5 A	0,5 A
Reference current (I_{ref})	5 A	10 A	10 A
Maximum current (I_{max})	45 A	100 A	100 A
Meter start-up current (I_{st})	0,02 A	0,04 A	0,04A
Rated frequency	50 Hz	50 Hz	50 Hz
Own consumption	2 W / 10 VA	2 W / 10 VA	2 W / 10 VA
Impulse output	1000 imp. / kWh	1000 imp. / kWh	1000 imp. / kWh
Maximum display	99999,9	999999,9	999999,9
Permissible humidity	95 %	95 %	95 %
Measurement accuracy class	Class B	Class B	Class B
IP rating	IP51	IP51	IP51
Insulation protection class	II	II	II
Start-up time	5 seconds	5 seconds	5 seconds
Operating temperature	-25 °C ... +55 °C	-25 °C ... +55 °C	-25 °C ... +55 °C
Mounting	on TS 35 rail	on TS 35 rail	on TS 35 rail
Additional information	Device complies with the MID Measuring Instruments Directive 2004/22/EC fully applicable from 30.10.2016	Device complies with the MID Measuring Instruments Directive 2004/22/EC fully applicable from 30.10.2016	Device complies with the MID Measuring Instruments Directive 2004/22/EC fully applicable from 30.10.2016
Dimensions A / B / C [mm]	97 / 64,5 / 17,5	104,5 / 66 / 72	100 / 66 / 72
Collective packaging			



MID
Measuring Instruments
Directive

These devices are compliant with the measuring instruments directive MID no. 2004/22/EC, which has been applicable in full scope since 30.10.2016. Unification of recommendations regarding measuring devices used in the European Union created a requirement for uniform legal metrological control in the scope of type approval and initial verification. The Simlic range of meters has the appropriate testing and documentation to assess this compliance.



SWN 3F



phase voltage indicator

Colour Cat. No.	
	85 132 012
System rated voltage AC (U _n)	3 x 230 V
Tightness	IP20
Wire connection clamps	3 x 2,5 mm ²
Dimensions A / B / C [mm]	18 / 90 / 64,5
Application	<ul style="list-style-type: none"> Power supply voltage indicator SWN 3F is intended for signalling the presence of voltage in a three-phase network. It is mounted on a TS 35 rail. Each phase corresponds to one LED. In the case of phase loss, the neon lamp associated with it will turn off. At lower voltage, the lamp glows fainter and turns off completely as voltage goes out. Applications: low-voltage installations, intended for automatics and control systems.
Mounting	on TS 35 rail
Collective packaging	



MRD50-16



single-phase socket 16 A

Cat. No.	89 066 006
Standard	PN 88/E-9320
Nominal operating frequency	50 Hz
Rated voltage	250 V
Rated current	16 A
Dimensions A / B / C [mm]	44,5 / 75,5 / 65
Clamp	L, N, PE
Cross-section of connection wires	1,5 ... 2,5 mm ²
IP rating	IP20
Collective packaging	5 pcs
Mounting	on TS 35 rail
Collective packaging	

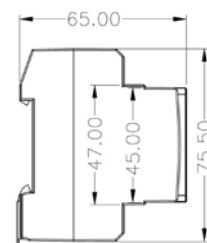

Intended use:

- standard plug type C, narrow version CEE 7/16, wide version CEE 7/17,
- dual plugs type E/F



1-PHASE FORK TYPE				
	SW1F 10 12M63A	SW1F 16 12M80A	SW1F 10 57M63A	SW1F 16 57M80A
	10 mm²	16 mm²	10 mm²	16 mm²
Cat. No.	81 991 006	81 993 006	81 991 106	81 993 106
Cross-section [mm ²]	10	16	10	16
Rated current [A]	63	80	63	80
Modules	12	12	57	57
Modular spacing [mm]	17,8	17,8	17,8	17,8
Weight [kg]	0,039	0,054	0,039	0,054
Collective packaging				
Accessories	<ul style="list-style-type: none"> end caps for 1-phase busbars ZSP1F protective cover for 10/16mm² busbars OSP-5M 	<ul style="list-style-type: none"> end caps for 1-phase busbars ZSP1F protective cover for 10/16mm² busbars OSP-5M 	<ul style="list-style-type: none"> end caps for 1-phase busbars ZSP1F protective cover for 10/16mm² busbars OSP-5M 	<ul style="list-style-type: none"> end caps for 1-phase busbars ZSP1F protective cover for 10/16mm² busbars OSP-5M

1-PHASE PIN TYPE				
	SS1F 10 12M63A	SS1F 16 12M80A	SS1F 10 57M63A	SS1F 16 57M80A
	10 mm²	16 mm²	10 mm²	16 mm²
Cat. No.	81 995 006	81 997 006	81 995 106	81 997 106
Cross-section [mm ²]	10	16	10	16
Rated current [A]	63	80	63	80
Modules	12	12	57	57
Modular spacing [mm]	17,8	17,8	17,8	17,8
Weight [kg]	0,033	0,046	0,033	0,046
Collective packaging				
Accessories	<ul style="list-style-type: none"> end caps for 1-phase busbars ZSP1F protective cover for 10/16mm² busbars OSP-5M 	<ul style="list-style-type: none"> end caps for 1-phase busbars ZSP1F protective cover for 10/16mm² busbars OSP-5M 	<ul style="list-style-type: none"> end caps for 1-phase busbars ZSP1F protective cover for 10/16mm² busbars OSP-5M 	<ul style="list-style-type: none"> end caps for 1-phase busbars ZSP1F protective cover for 10/16mm² busbars OSP-5M

	ZSP12-F	OSP-5M
	end cap for 1-phase busbars (10mm² / 16mm²)	protective cover for busbars (10mm² / 16mm²)
Cat. No.	81 999 006	81 999 004
Cross-section [mm ²]	10/16	10/16
Collective packaging		



3-PHASE FORK TYPE				
	SW3F 10 12M63A	SW3F 16 12M80A	SW3F 10 57M63A	SW3F 16 57M80A
	10 mm²	16 mm²	10 mm²	16 mm²
Cat. No.	81 992 006	81 994 006	81 992 106	81 994 106
Cross-section [mm ²]	10	16	10	16
Rated current [A]	63	80	63	80
Modules	12	12	57	57
Modular spacing [mm]	17,8	17,8	17,8	17,8
Weight [kg]	0,085	0,12	0,454	0,939
Collective packaging				
Accessories	• end caps for 3-phase busbars ZSP3F-10 (81 999 106)	• end caps for 3-phase busbars ZSP3F-10 (81 999 106)	• end caps for 3-phase busbars ZSP3F-10 (81 999 106)	• end caps for 3-phase busbars ZSP3F-10 (81 999 106)

3-PHASE PIN TYPE				
	SS3F 10 12M63A	SS3F 16 12M80A	SS3F 10 57M63A	SS3F 16 57M80A
	10 mm²	16 mm²	10 mm²	16 mm²
Cat. No.	81 996 006	81 998 006	81 996 106	81 998 106
Cross-section [mm ²]	10	16	10	16
Rated current [A]	63	80	63	80
Modules	12	12	57	57
Modular spacing [mm]	17,8	17,8	17,8	17,8
Weight [kg]	0,08	0,112	0,425	0,61
Collective packaging				
Accessories	• end caps for 3-phase busbars ZSP3F-10 (81 999 106)	• end caps for 3-phase busbars ZSP3F-10 (81 999 106)	• end caps for 3-phase busbars ZSP3F-10 (81 999 106)	• end caps for 3-phase busbars ZSP3F-10 (81 999 106)

3 - PHASE FOR RESIDUAL PROTECTION				
	SW3F (3P+N) 10 12M63A	SW3F (3P+N) 16 12M80A	SS3F (3P+N) 10 12M63A	SS3F (3P+N) 16 12M80A
	10 mm²	16 mm²	10 mm²	16 mm²
Cat. No.	81 992 206	81 994 206	81 996 206	81 998 206
Cross-section [mm ²]	10	16	10	16
Rated current [A]	63	80	63	80
Modules	12	12	12	12
Modular spacing [mm]	17,8	17,8	17,8	17,8
Weight [kg]	0,085	0,12	0,08	0,112
Collective packaging				
Accessories	• end caps for 3-phase busbars ZSP3F-10 (81 999 106)	• end caps for 3-phase busbars ZSP3F-10 (81 999 106)	• end caps for 3-phase busbars ZSP3F-10 (81 999 106)	• end caps for 3-phase busbars ZSP3F-10 (81 999 106)

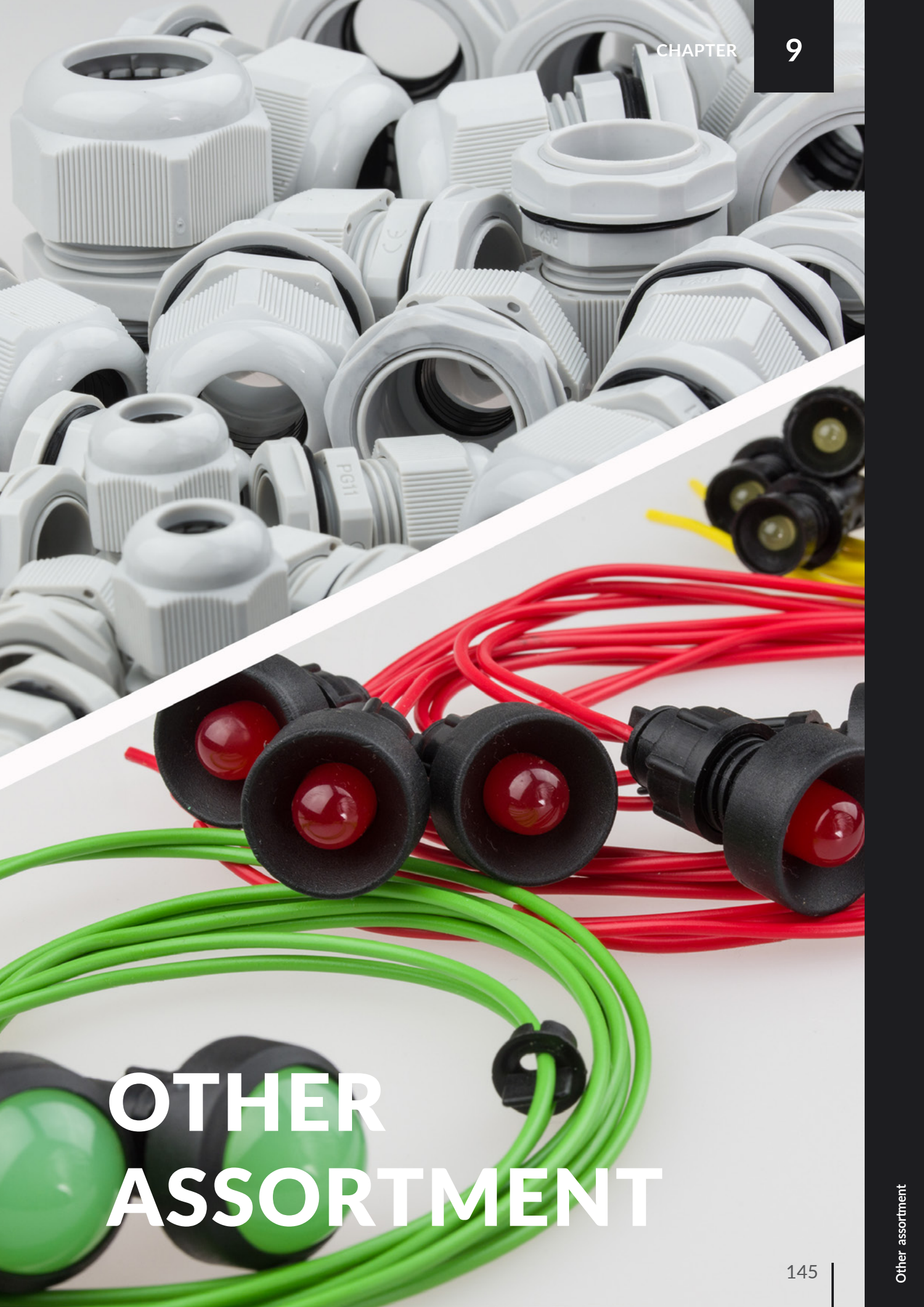

OTHER ASSORTMENT

Material	Polyamide PA 66
RAL colour	RAL7035 light grey
Set includes	Gasket, washer, nut
Operating temperature	-20 °C ... +100 °C
IP rating	IP68
Tolerance	± 5%

Cable glands with washer and PG screw thread

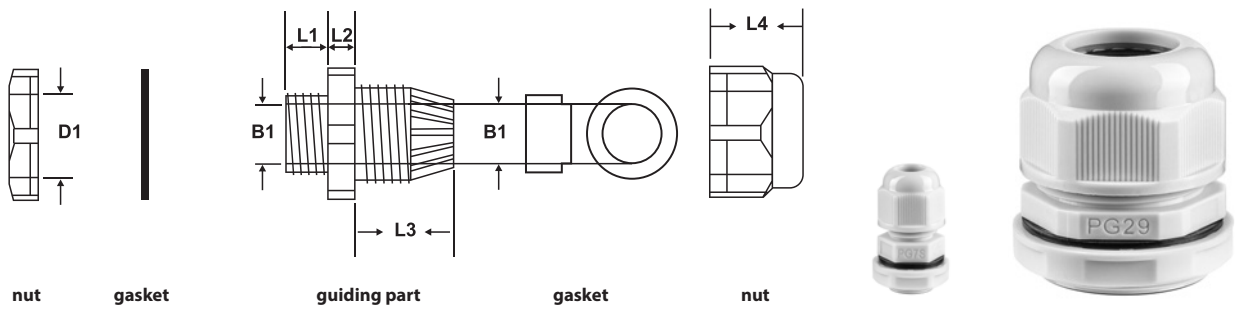

No.	Cat. No.	Type	D1 (mm)	B1 (mm)	L1 (mm)	L2 (mm)	L3 (mm)	L4 (mm)	Wire diameter range (mm)	Collective packaging (pcs)	Colours
1	87 000 002	PG7G-R	11	7	8,5	4,9	14,4	14,3	3 - 6,5	50	●
2	87 001 002	PG9G-R	13,9	8,5	9,5	5	17,6	17,0	4 - 8	50	●
3	87 002 002	PG11G-R	17,3	11	10,3	4,9	18,4	19,3	5 - 10	50	●
4	87 003 002	PG13.5G-R	19	13	10,4	5	20,2	19,8	6 - 12	50	●
5	87 004 002	PG16G-R	21,2	15,5	11,3	5	22,6	21,5	10 - 14	50	●
6	87 005 002	PG21G-R	26,6	20	12,5	5,5	24,8	25,5	13 - 18	50	●
7	87 006 002	PG29G-R	35,5	27,4	12,2	6	28	28,0	18 - 25	25	●
8	87 007 002	PG36G-R	45,3	33,2	14,8	6,5	33	31,0	22 - 32	10	●
9	87 008 002	PG42G-R	52,5	42,3	15,2	7	36,4	38,2	32 - 38	10	●
10	87 009 002	PG48G-R	57,8	49,2	18,2	7	38,3	39,3	37 - 44	10	●

Cable glands with a MG metric screw head

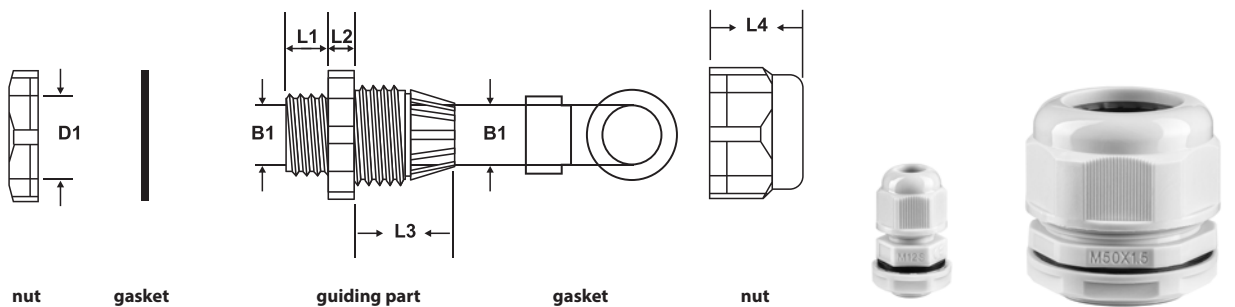

No.	Cat. No.	Type	Thread pitch [mm]	D1 (mm)	B1 (mm)	L1 (mm)	L2 (mm)	L3 (mm)	L4 (mm)	Wire diameter range (mm)	Collective packaging (pcs)	Colours
1	87 010 002	M12G-R	1,5	10,4	7	8,4	5	14,8	14,3	3 - 6,5	50	●
2	87 011 002	M16G-R	1,5	14,2	10,6	10,2	5	18,3	19,3	5 - 10	50	●
3	87 012 002	M20G-R	1,5	18,7	7	10,2	5	20,2	19,8	6 - 12	50	●
4	87 013 002	M25G-R	1,5	23,5	19,7	12,2	5,5	24,7	25,4	13 - 18	50	●
5	87 014 002	M32G-R	1,5	30,3	21,5	12	6	26,1	25,6	14 - 20	25	●
6	87 015 002	M40G-R	1,5	38,5	33,5	15,2	6,5	32,5	30,5	22 - 32	10	●
7	87 016 002	M50G-R	1,5	48,3	43,5	15,2	7	36,4	37,8	20 - 38	10	●
8	87 017 002	M63G-R	1,5	61,2	48,7	17,9	7	38,7	39,0	37 - 44	5	●

Indicator lights are intended for signalling the status of electric circuits. They consist of single- or two-colour LEDs with diameters of 3, 5, 10 and 20 mm, as well as resistors, diodes and a holder. They constitute an alternative solution to incandescent, neon and other lamps.

In particular, they are characterised by:

- long service life (with operation 6h/day = at least 12 years)
- high luminance
- resistance to electrical surges
- easy mounting
- low power consumption
- reliability

Protection rating IP 20. Connecting wire LGY 0,5 mm².

It is possible to mount the indicator lights Klp 10 and Klp 20 in \varnothing 22,5 mounting holes with the use of a PR 13/22 reduction pads.

It is possible to provide the covers in different colours (orange - O, blue - B and white - W on request) and in metallised housings. The lights are also made with an alternating light colour option (green-red).

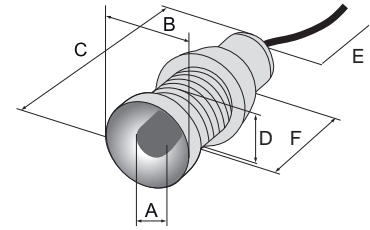

A - diode diameter
B - housing diameter
C - body length
D - mounting hole diameter
E - wire length
F - max. thickness of mounting plate

Indicator lights*		
	cover diameter \varnothing 3 mm	cover diameter \varnothing 3 mm
Colours Cat. No. Designation		
Green ●	84 403 005 Klp 3G/12-24V	84 503 005 Klp 3G/230V
Red ●	84 403 001 Klp 3R/12-24V	84 503 001 Klp 3R/230V
Yellow ●	84 403 004 Klp 3Y/12-24V	84 503 004 Klp 3Y/230V
Cover diameter	3 mm	3 mm
Rated voltage	12 ... 24 V AC / DC	230 V AC / DC
Dimensions		
A / B / C / D / E / F [mm]	3 / 8 / 20 / 6 / 300 / 8	3 / 8 / 20 / 6 / 300 / 8
Max. current/power consumption	20 mA / 1 W	5 mA / 1 W
Brightness	40-60 mcd ● 400-600 mcd ● 100-250 mcd ●	40-60 mcd ● 400-600 mcd ● 100-250 mcd ●
Notes	connecting wires in two colours	connecting wires in one colour
Collective packaging		

*Only on request.

Indicator lights		
	cover diameter \varnothing 5 mm	cover diameter \varnothing 5 mm
Colours Cat. No. Designation		
Green ●	84 405 005 Klp 5G/12-24V	84 505 005 Klp 5G/230V
Red ●	84 405 001 Klp 5R/12-24V	84 505 001 Klp 5R/230V
Yellow ●	84 405 004 Klp 5Y/12-24V	84 505 004 Klp 5Y/230V
Blue ●	84 405 003 Klp 5B/12-24V	84 505 003 Klp 5B/230V
Orange ●	84 405 008 Klp 5O/12-24V	84 274 008 Klp 5O/230V
White ○	84 405 006 Klp 5W/12-24V	84 505 006 Klp 5W/230V
Red-green ●●	84 405 015 Klp 5GR/12-24V	84 505 015 Klp 5GR/230V
Cover diameter	5 mm	5 mm
Rated voltage	12 ... 24 V AC / DC	230 V AC / DC
Dimensions		
A / B / C / D / E / F [mm]	5 / 12 / 30 / 10 / 300 / 8	5 / 12 / 30 / 10 / 300 / 8
Max. current/power consumption	20 mA / 1 W	5 mA / 1 W
Brightness	20-60 mcd ● 1000-1500 mcd ● 600-1000 mcd ● 40-60 mcd ● / 12-30 mcd ● / 2000-3000 mcd ○	20-60 mcd ● 1000-1500 mcd ● 600-1000 mcd ● 40-60 mcd ● / 12-30 mcd ● / 2000-3000 mcd ○
Notes	connecting wires in two colours	connecting wires in one colour
Collective packaging		

Multi-colour indicator lights have 3 supplying wires. Two in colours of glowing and third colour depending on the current: in brown colour for direct colour and black for alternating current.

Indicator lights



	cover diameter \varnothing 10 mm	cover diameter \varnothing 10 mm
Colours Cat. No. Designation		
Green ●	84 410 005 Klp 10G/12-24V	84 510 005 Klp 10G/230V
Red ●	84 410 001 Klp 10R/12-24V	84 510 001 Klp 10R/230V
Yellow ●	84 410 004 Klp 10Y/12-24V	84 510 004 Klp 10Y/230V
Blue ●	84 410 003 Klp 10B/12-24V	84 510 003 Klp 10B/230V
Orange ●	84 410 008 Klp 10O/12-24V	84 510 008 Klp 10O/230V
White ○	84 410 006 Klp 10W/12-24V	84 510 006 Klp 10W/230V
Red-green ●●	84 410 015 Klp 10GR/12-24V	84 510 015 Klp 10GR/230V
Yellow-green ●●	84 410 054 Klp 10GY/12-24V	—
Cover diameter	10 mm	10 mm
Rated voltage	12 ... 24 V AC / DC	230 V AC / DC
Dimensions		
A / B / C / D / E / F [mm]	10 / 22 / 42 / 13 / 300 / 10	10 / 22 / 42 / 13 / 300 / 10
Max. current/power consumption	20 mA / 1 W	5 mA / 1 W
Brightness	20-70 mcd ● 800-1200 mcd ● 20-50 mcd ● 18-60 mcd ● / 40-150 mcd ● / 1000-3000 mcd ○	20-70 mcd ● 800-1200 mcd ● 20-50 mcd ● 18-60 mcd ● / 40-150 mcd ● / 1000-3000 mcd ○
Notes	connecting wires in two colours	connecting wires in one colour
Collective packaging		

Note: There is a possibility to mount the indicator lights in the mounting hole \varnothing 22.5 with the use of PR 13/22.

Multi-colour indicator lights have 3 supplying wires. Two in colours of glowing and third colour depending on the current: in brown colour for direct colour and black for alternating current.

Indicator lights



	cover diameter \varnothing 20 mm	cover diameter \varnothing 20 mm
Colours Cat. No. Designation		
Green ●	84 420 005 Klp 20G/12-24V	84 520 005 Klp 20G/230V
Red ●	84 420 001 Klp 20R/12-24V	84 520 001 Klp 20R/230V
Yellow ●	84 420 004 Klp 20Y/12-24V	84 520 004 Klp 20Y/230V
Blue ●	84 420 003 Klp 20B/12-24V	84 520 003 Klp 20B/230V
Orange ●	84 420 008 Klp 20O/12-24V	84 520 008 Klp 20O/230V
White ○	84 420 006 Klp 20W/12-24V	84 520 006 Klp 20W/230V
Red-green ●●	84 420 015 Klp 20GR/12-24V	84 520 015 Klp 20GR/230V
Cover diameter	20 mm	20 mm
Rated voltage	12 ... 24 V AC / DC	230 V AC / DC
Dimensions		
A / B / C / D / E / F [mm]	20 / 25 / 48 / 13 / 300 / 10	20 / 25 / 48 / 13 / 300 / 10
Max. current/power consumption	20 mA / 1 W	5 mA / 1 W
Brightness	30-60 mcd ● 60-100 mcd ● 50-190 mcd ● 80-120 mcd ● / 60-120 mcd ● / 180-200 mcd ○	30-60 mcd ● 60-100 mcd ● 50-190 mcd ● 80-120 mcd ● / 60-120 mcd ● / 180-200 mcd ○
Notes	connecting wires in two colours	connecting wires in one colour
Collective packaging		

Note: There is a possibility to mount the indicator lights in the mounting hole \varnothing 22.5 with the use of PR 13/22.

Multi-colour indicator lights have 3 supplying wires. Two in colours of glowing and third colour depending on the current: in brown colour for direct colour and black for alternating current.

	EARTHING BANDS			
	OU-1	OU-2	OU-3	OU-4
	Ø 8 ... 18 mm	Ø 8 ... 50 mm	Ø 8 ... 114 mm	Ø 8 ... 165 mm
Colour Cat. No.				
Grey ●	84 300 000	84 301 000	84 302 000	84 303 000
Rated clamp cross-section	2,5 ... 16 mm ²	2,5 ... 16 mm ²	2,5 ... 16 mm ²	2,5 ... 16 mm ²
Pipe diameter range	1/8 ... 3/8" / Ø 8 ... 18 mm	1/8 ... 1 1/2" / Ø 8 ... 50 mm	1/8 ... 4" / Ø 8 ... 114 mm	1/8 ... 6" / Ø 8 ... 165 mm
Band length	136 mm	209 mm	428 mm	605 mm
Collective packaging				

stainless steel band

	GEL JOINTS		
	MGB2	MGB3	MGB5
	2 x 2,5 mm ²	3 x 2,5 mm ²	5 x 2,5 mm ²
Colour Cat. No.			
Grey ●	89 000 002	89 001 002	89 002 002
Operating temp. [C]	90°	90°	90°
Weight [kg]	0,024	0,03	0,054
Dimensions A / B / C [mm]	38 / 42,4 / 26	38 / 52 / 26	46,2 / 74 / 26
Standards	EN 50393 (0,6/1kV) EN 60529, EN 60695-2-11	EN 50393 (0,6/1kV) EN 60529, EN 60695-2-11	EN 50393 (0,6/1kV) EN 60529, EN 60695-2-11
Collective packaging			

NEW!
MiniGelBox













SIMBLOCK®		SBB 16																																	
Compliance with standards:																																			
• IEC 60947-7-1																																			
		insulated terminal 2x16 mm ²																																	
Colour Cat. No.																																			
Grey ●		81 550 002																																	
Blue ●		81 550 003																																	
Green ●		81 550 005																																	
Brown ●		81 550 015																																	
Black ●		81 550 007																																	
			<table border="1"> <thead> <tr> <th colspan="2">Current data</th> </tr> </thead> <tbody> <tr> <td>Standard</td> <td>IEC</td> </tr> <tr> <td>Rated voltage</td> <td>690 V AC</td> </tr> <tr> <td>Rated current</td> <td>114 A (Cu)</td> </tr> <tr> <td>Rated cross-section</td> <td></td> </tr> <tr> <td>Input</td> <td>busbar min 10 mm</td> </tr> <tr> <td>Output (wire)</td> <td>2 x (1,5 ... 16) mm²</td> </tr> <tr> <td>Output (wire with sleeve)</td> <td>2 x (1 ... 10) mm²</td> </tr> <tr> <td>Mounting</td> <td>busbar 10 mm</td> </tr> <tr> <td>External dimensions</td> <td></td> </tr> <tr> <td>W / H / H1 / L [mm]</td> <td>15,2 / 55,2 / 33,2 / 47,8</td> </tr> <tr> <td>Weight</td> <td>93 g</td> </tr> <tr> <td>Additional information</td> <td>insulated housing</td> </tr> <tr> <td>Collective packaging</td> <td></td> </tr> </tbody> </table>					Current data		Standard	IEC	Rated voltage	690 V AC	Rated current	114 A (Cu)	Rated cross-section		Input	busbar min 10 mm	Output (wire)	2 x (1,5 ... 16) mm ²	Output (wire with sleeve)	2 x (1 ... 10) mm ²	Mounting	busbar 10 mm	External dimensions		W / H / H1 / L [mm]	15,2 / 55,2 / 33,2 / 47,8	Weight	93 g	Additional information	insulated housing	Collective packaging	
Current data																																			
Standard	IEC																																		
Rated voltage	690 V AC																																		
Rated current	114 A (Cu)																																		
Rated cross-section																																			
Input	busbar min 10 mm																																		
Output (wire)	2 x (1,5 ... 16) mm ²																																		
Output (wire with sleeve)	2 x (1 ... 10) mm ²																																		
Mounting	busbar 10 mm																																		
External dimensions																																			
W / H / H1 / L [mm]	15,2 / 55,2 / 33,2 / 47,8																																		
Weight	93 g																																		
Additional information	insulated housing																																		
Collective packaging																																			



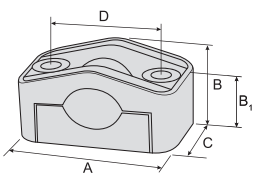

	RAIL CLAMPS			
	ZS 16 S-5	ZS 16 S-10	ZS 35 S-5	ZS 35 S-10
				
Cat. No.	84 388 000	84 389 000	84 390 000	84 391 000
Rated voltage [V]	690	690	690	690
Rated current [A]	180	180	270	270
Rated cross-section	1,5 ... 16 mm ²	1,5 ... 16 mm ²	4 ... 35 mm ²	4 ... 35 mm ²
Busbar thickness [mm]	5	10	5	10
Tightening torque [Nm]	3	3	10	10
Clamping screw	M5	M5	M8	M8
Weight [kg]	0,022	0,022	0,044	0,046
Collective packaging				

	ZS 50 S-5	ZS 50 S-10	ZS 70 S-5	ZS 70 S-10
				
Cat. No.	84 392 000	84 393 000	84 394 000	84 395 000
Rated voltage [V]	690	690	690	690
Rated current [A]	315	315	400	400
Rated cross-section	10 ... 50 mm ²	10 ... 50 mm ²	16 ... 70 mm ²	16 ... 70 mm ²
Busbar thickness [mm]	5	10	5	10
Tightening torque [Nm]	10	10	10	10
Clamping screw	M8	M8	M8	M8
Weight [kg]	0,048	0,049	0,0625	0,068
Collective packaging				

	ZS 120 S-5	ZS 120 S-10	ZS 185 S-5	ZS 185 S-10
				
Cat. No.	84 396 000	84 397000	84 398 000	84 399 000
Rated voltage [V]	690	690	690	690
Rated current [A]	440	440	500	500
Rated cross-section	16 ... 120 mm ²	16 ... 120 mm ²	50 ... 185 mm ²	50 ... 185 mm ²
Busbar thickness [mm]	5	10	5	10
Tightening torque [Nm]	22	22	22	22
Clamping screw	M10	M10	M10	M10
Weight [kg]	0,088	0,091	0,102	0,096
Collective packaging				

EQUIPOTENTIAL STRIPS		
	SWP1	SWP2
		
	25 mm ² / 5x6 mm ²	50 mm ² / 7x25 mm ² / 30x4 mm ²
Colour Cat. No.	Grey ● 84 331 002	Grey ● 84 332 002
Rated cross-section	1 x 25 mm ² ; 5 x 6 mm ²	1 x 50 mm ² ; 7 x 6 ... 25 mm ² ; 1 x 30 x 4 mm ²
Current data	Rated voltage 690 V Rated current 101 A	Rated voltage 690 V Rated current 76 A
External dimensions	A / B / C [mm] 40 / 64 / 32 Weight 69 g	52 / 172 / 42 240 g
Application	Clamp adapted to solid wire connections or wires ended with the tips of H, HI type. Mounting to the substrate.	Clamp adapted to wire connections ended with cable lugs, e.g. the following types: KO, KW, KOI, LOI, KWI etc. Mounting to the substrate.
Collective packaging	 	

CABLE HOLDERS		
	UKR1	UKR2
		
	26-46 mm	45-70 mm
Colour Cat. No.	Black ● 84 328 007	Black ● 84 329 007
Cable diameter range	26 - 46 mm	45 - 70 mm
Weight	85 g	118 g
Dimensions	A / B / B1 / C / D [mm] 98 / 55 / 45 / 59 / 69 ø hole 11 mm	124 / 67 / 44,5 / 59 / 94 ø hole 12 mm
Operating temperature	-30 °C ... +85 °C	-30 °C ... +85 °C
Additional information	cable holders for mounting wires in the control switchboards	
Collective packaging		

RAIL INSULATORS		
	SW-4	SW-8
		
	ø 50 mm	ø 60 mm
Colour Cat. No.	White ○ 84 327 006	White ○ 84 288 006
Rated voltage	1 kV	1 kV
Dimensions	Height / Lower diameter / Upper diameter 40 mm / ø 50 mm / ø 33 mm	40 mm / ø 60 mm / ø 40 mm
Mounting screw	M10	M12
Weight	44,6 g	67,4 g
Additional information	Rail insulators are intended for insulation of rails in the installation and distribution devices for rated voltage up to 1000 V and frequency up to 100 Hz.	
Collective packaging		

Cable holders with a FLOP type nail are made of polypropylene. They are intended for fixing cables or single cable wires with the use of hardened nails driven into a substrate.

“O” type flops for round conductors

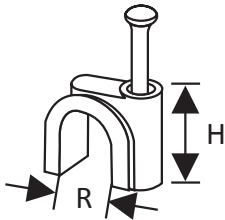

Cat. No.	Type	Dimensions (R / H) [mm]	Wire diameter [mm]	Wire type	Collective packaging (pcs)	Colours
89 072 006	FlopO3	3,5 / 4,5	3,5	round	100	white
89 073 006	FlopO4	4 / 5,3	4	round	100	white
89 074 006	FlopO5	5 / 6,5	5	round	100	white
89 075 006	FlopO6	6 / 8,1	6	round	100	white
89 076 006	FlopO7	7 / 8,7	7	round	100	white
89 077 006	FlopO8	8 / 9,6	8	round	100	white
89 078 006	FlopO10	10 / 11,7	10	round	100	white
89 079 006	FlopO12	12 / 12,8	12	round	100	white
89 080 006	FlopO14	14 / 14,9	14	round	100	white
89 081 006	FlopO16	16 / 16,9	16	round	100	white

“P” type flops for flat conductors

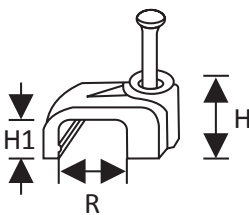

Cat. No.	Type	Dimensions (R / H / H1) [mm]	Nominal wire cross-section [mm ²]	Wire type	Collective packaging (pcs)	Colours
89 082 006	FlopP4/4	4,0 / 6,0 / 3,8	2x0,75	flat	100	white
89 083 006	FlopP6/4	6,0 / 6,5 / 4,1	2x1	flat	100	white
89 084 006	FlopP7/4,5	7,0 / 7,0 / 4,7	2x1,5	flat	100	white
89 085 006	FlopP8/5	8,0 / 7,5 / 5,0	2x2,5	flat	100	white
89 086 006	FlopP10/6	10 / 8,6 / 5,7	3x1,5	flat	100	white
89 087 006	FlopP12/6	12 / 9,0 / 6,1	3x2,5	flat	100	white

Hammered double cable clips – UWT type



Flat cable holder. It is made of polypropylene and it is intended for laying cable routes, as well as routing and parallel fixing of two flat cables. Moreover, it is also used to make the so-called spurs from the boxes.

Cat. No.	Type	For cable type	Dimensions A [mm]	Dimensions a [mm]	Dimensions L [mm]	Dimensions l [mm]	Size of a drill used to make a hole for a clip [mm]	Collective packaging (pcs)	Colours
89 139 306	UWT-1	2 x YDYp (2 x 2,5 mm ²) or YDYp (3 x 1,0 mm ²) for spurs from the boxes	27	11	43	35	6/7	1	white
89 140 306	UWT-2	2 x YDYp (3 x 1,5 mm ²) or YDYp (3 x 2,5 mm ²)	31	13	43	35	6/7	1	white

Hammered hook type clips – UWH type



Hook clamp for round cables. It is made of polypropylene and it is used alternatively instead of flop-type cable clips. It is used in all cases, in which it is impossible to mount a clip with the use of hardened nail, but it is possible to drill a hole. Sometimes, this clip is used instead of UWO and UWP clips.

Cat. No.	Type	For cable type	Dimensions d [mm]	Dimensions L [mm]	Dimensions B [mm]	Size of a drill used to make a hole for a clip [mm]	Collective packaging (pcs)	Colours	
89 141 306	UWH-10	YDY (2x1 mm ²); (2x1,5 mm ²); (2x2,5 mm ²); (3x1 mm ²); (3x1,5 mm ²); (3x2,5 mm ²); (4x1 mm ²)	9	45	5	5	5	100	white
89 142 306	UWH-16	YDY (3x6 mm ²); (4x4 mm ²); (4x6 mm ²); (5x2,5 mm ²); (5x4 mm ²)	13	60	6	6	6	100	White

Hammered cable clips – UWO , UWP type



A range of hammered clips for round (UWO) or flat (OWP) cables. These products are made of polypropylene and they are usually used to fix the cables to the walls and floors. In particular, it is often used as a clip holding a cable on the wall during placement of plaster boards, drywalls or during implementation of levelling, floor etc.

Cat. No.	Type	For cable type	Dimensions d [mm]	Dimensions L [mm]	Dimensions B [mm]	Size of a drill used to make a hole for a clip [mm]	Collective packaging (pcs)	Colours
89 126 306	UWO-6	6 mm ²	6	31	-	5	100	white
89 127 306	UWO-8	8 mm ²	8	43	-	6/7	100	white
89 128 306	UWO-10	10 mm ²	10	43	33	6/7	100	white
89 129 306	UWO-12	12 mm ²	12	49	35	7/9	50	white
89 130 306	UWO-14	14 mm ²	14	49	32	7/9	50	white
89 131 306	UWO-16	15 mm ²	15	58	40	7/9	50	white
89 132 306	UWO-18	18 mm ²	18	58	40	7/9	50	white
89 133 306	UWO-20	20 mm ²	20	58	37	7/9	50	white
89 134 306	UWP-2	YDYp 3x1,0 mm ²	11	43	34	6/7	100	white
89 135 306	UWP-3	YDYp 3 x 1,5 mm ² ; 3 x 2,5 mm ²	13	43	34	6/7	100	white
89 136 306	UWP-4	YDYp 4 x 1,5 mm ² ; 4 x 2,5 mm ²	16	43	34	6/7	100	White
89 137 306	UWP-5	YDYp 5 x 1,5 mm ² ; 5 x 2,5 mm ²	18	43	34	6/7	100	white
89 138 306	UWP-6	YDYp 5 x 4 mm ² ; 5 x 6 mm ²	25	43	34	8	50	White

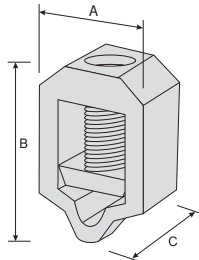

	V-CLAMP		
	V25-120SW	V35-240SW	V2x35-240SW
	120 mm²	240 mm²	2x240 mm²
Colour Cat. No.	84 341 000	84 342 000	84 343 000
Rated connectivity	25 ... 120 mm ²	35 ... 185 mm ²	2 x (70 ... 240 mm ²)
sm	25 ... 120 mm ²	35 ... 240 mm ²	2 x (95 ... 300 mm ²)
se	16 ... 95 mm ²	25 ... 150 mm ²	2 x (50 ... 120 mm ²)
rm	16 ... 95 mm ²	25 ... 95 mm ²	2 x (70 ... 150 mm ²)
re			
Dimensions A / B / C [mm]	28 / 38 / 21	35 / 49 / 23	37 / 76 / 23
Rated cross-section	95 mm ²	120 mm ²	150 mm ²
Tightening torque	20 Nm	30 Nm	30 Nm
Notes	Materials: body – aluminium alloy; clamp – galvanized brass; Allen screw SW 6 - galvanised steel. Application: for connecting aluminium and copper electric-power cables to the rails in distribution boards of connectors, disconnectors, fuse bases. Suitable for all types of cables (sectorial multi-wire cables - sm, sectorial single-wire cables - se, round multi-wire cables - rm, round single-wire cables - re.)		
Collective packaging			

	CONNECTION PLATE FOR V-CLAMP	
	P25-120V	P35-240V
	120 mm²	240 mm²
Colour Cat. No.	84 273 000	84 277 000
Rated connectivity		
Dimensions A / B / C / D [mm]	20 / 64 / 3 / 10	25 / 74 / 3 / 10
Material	galvanised copper	galvanised copper
Application	connection plate for the connector V25-120SW	connection plate for the connector V35-240SW, V2x35-240SW
Collective packaging		

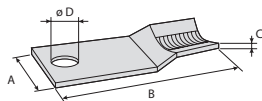

OUR BRANDS

	page		
Surface junction boxes	112	FASTBOX® & HOOK	
Mounting ring	32	FASTRING®	
Wire connectors	50	IDEALNA® SZYBKOZŁĄCZKA	
Gel cable joints	149	MiniGelBox	
Multipole junction boxes	104	MULTIBOX®	
Multipole junction boxes	96	Multiwall®	
Multipole junction boxes	99	Multiwall® SLIM	
Rail-mounted terminal blocks	26	NowA®	
Terminal and distribution blocks	39, 57	SIMBLOCK®	
Digital electricity meters	141	SIMLIC®	
Surge arresters	134	SIMTEC®	



Przedsiębiorstwo SIMET Spółka Akcyjna
Al. Jana Pawła II 33
58-506 Jelenia Góra
Poland

Domestic Sales Department:
phone: +48 75 64 71 492
fax.: +48 75 64 72 062
sprzedaz@simet.com.pl

Foreign Sales Department:
phone: +48 75 64 71 481
export@simet.com.pl



SimetSA



Simet_SA



simet.com.pl