

REV.	DESCRIPTION	DRAWN	CHECKED	APPROVED
A	NEW RELEASE	WPY 12/15/25'		



NOTES:

- 1.Materials: Copper alloy.
- 2:Plating: Nickel plating.
- 3:Part number code:
DS0089-BOX-01

GENERAL TOLERANCE		ANGLE TOLERANCE		PROJECTION		TITLE	Screws &Nuts Set	
X.	±0.30	X.	±2°	UNITS	mm			
.X	±0.20	.X	±1°	SHEET SIZE	A4	SERIES	Screws &Nuts Series	
.XX	±0.15	.XX	±0.5°	晨翔电子有限公司 CONNFY CONNFY ELECTRONIC CO. LTD				
DRAWING TYPE		CUSTOMER DRAWING						
SCALE	1:1	SHEET	1 OF 4					
DRAWING NO.		DS0089-BOX-01						

REV.	DESCRIPTION	DRAWN	CHECKED	APPROVED
A	NEW RELEASE	WPY 12/15/25'		

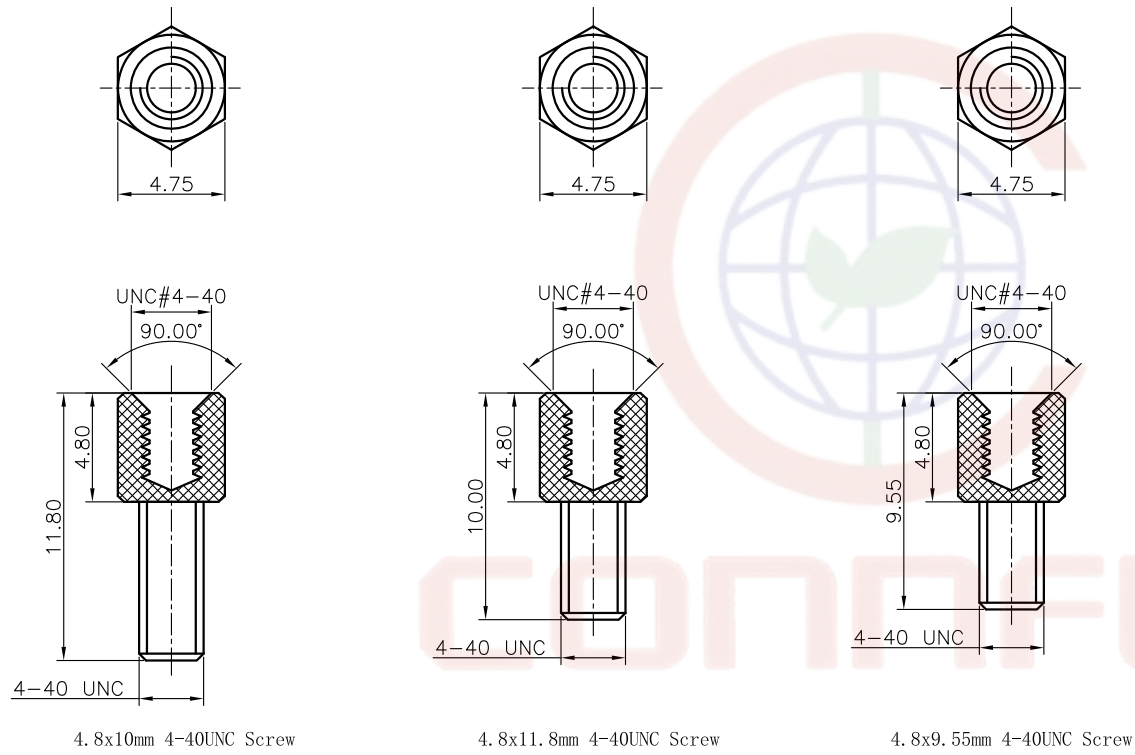

GENERAL TOLERANCE		ANGLE TOLERANCE	
X.	±0.30	X.	±2°
.X	±0.20	.X	±1°
.XX	±0.15	.XX	±0.5°

PROJECTION		TITLE	Screws	
UNITS	mm	SERIES	Screws & Nuts Series	
SHEET SIZE	A4			

DRAWING TYPE	CUSTOMER DRAWING		
SCALE	1:1	SHEET	2 OF 4
DRAWING NO.	DS0089-BOX-01		

晨翔电子有限公司
CONNFly CONNFly ELECTRONIC CO. LTD

REV.	DESCRIPTION	DRAWN	CHECKED	APPROVED
A	NEW RELEASE	WPY 12/15/25'		

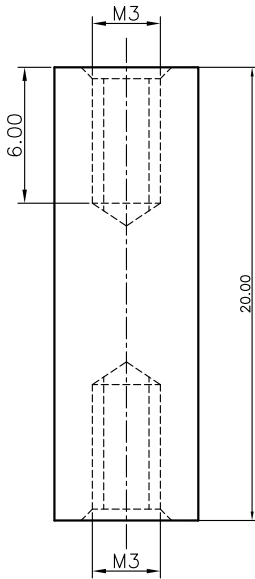
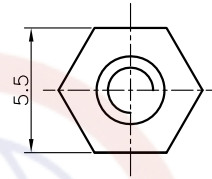
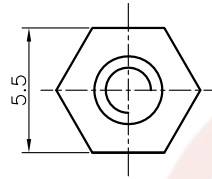
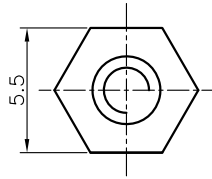

5.5x20mm M3 Nut

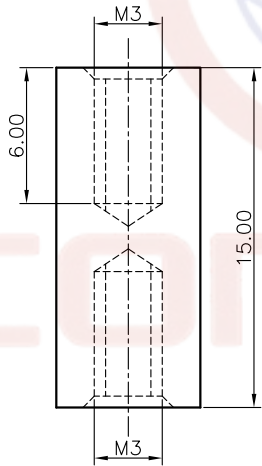

5.5x15mm M3 Nut

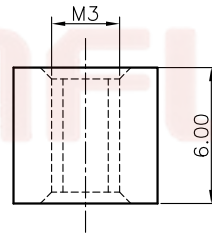

5.5x6mm M3 Nut

GENERAL TOLERANCE		ANGLE TOLERANCE		PROJECTION		TITLE	Nut	
X.	±0.30	X.	±2°	UNITS	mm			
.X	±0.20	.X	±1°	SHEET SIZE	A4	SERIES	Screws &Nuts Series	
.XX	±0.15	.XX	±0.5°	晨翔电子有限公司 CONNFLY CONNFLY ELECTRONIC CO. LTD				
DRAWING TYPE		CUSTOMER DRAWING						
SCALE	1:1	SHEET	3 OF 4					
DRAWING NO.		DS0089-BOX-01						

REV.	DESCRIPTION	DRAWN	CHECKED	APPROVED
A	NEW RELEASE	WPY 12/15/25'		

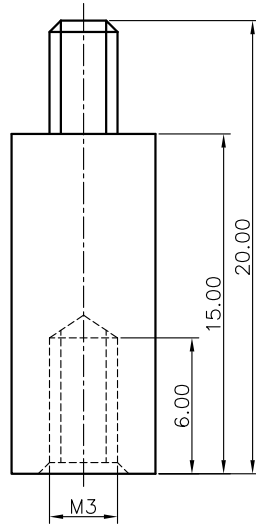
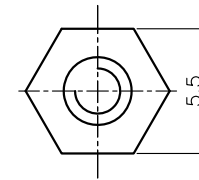
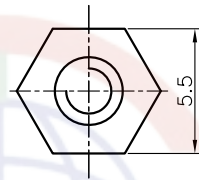
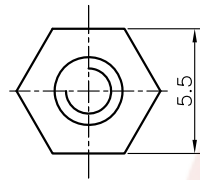
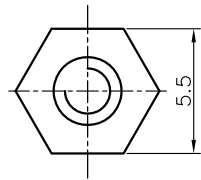

5.5x21mm M3 Screw

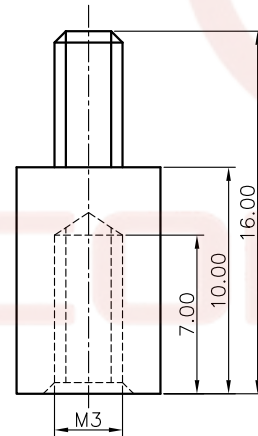

5.5x16mm M3 Screw

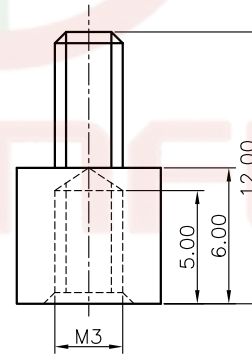

5.5x12mm M3 Screw

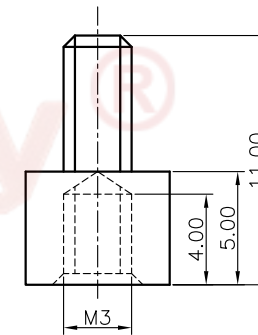

5.5x11mm M3 Screw

GENERAL TOLERANCE		ANGLE TOLERANCE	
X.	±0.30	X.	±2°
.X	±0.20	.X	±1°
.XX	±0.15	.XX	±0.5°

PROJECTION		TITLE	Screws	
UNITS	mm	SERIES	Screws & Nuts Series	
SHEET SIZE	A4			

DRAWING TYPE	CUSTOMER DRAWING		
SCALE	1:1	SHEET	4 OF 4
DRAWING NO.	DS0089-BOX-01		

 晨翔电子有限公司
CONNFLY CONNFLY ELECTRONIC CO. LTD